



메인보드 8M 연결 및 설치방법



세그먼트창

현재의 모드표시와 리모컨 설정을 위한 창



Remote receiver sensor 연결 (F, 7 MODE)

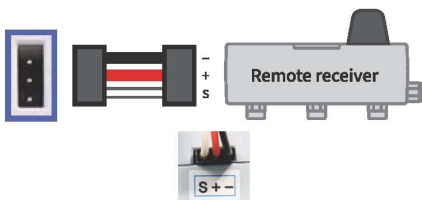

모터 연결



IR SENSOR (C MODE)



메인보드 모드설정방법

- 1 전원스위치를 누른다.
-전원 ON
- 2 모드스위치를 연속해서 누른다.
-모드변경
- 3 선택하려는 모드에서 3초간 기다린다.
-세그먼트 창이 3번 깜빡 거린다.
- 4 모드 설정 완료

메인보드 채널설정방법

- 1 메인보드의 전원을 끈다.
- 2 모드스위치를 누른 상태에서 전원스위치를 켜다.
- 3 세그먼트 창에는 현재 저장된 채널이 표시된다.
- 4 모드스위치를 눌러 채널을 변경한다
- 5 선택하려는 번호에서 3초간 기다린다.
-채널 설정이 완료되면 세그먼트 창이 깜빡 거린다.

Wired Remote controller 유선리모컨



분리도구 사용법

Example 1

셀의 돌기와 돌기를 분리할 때

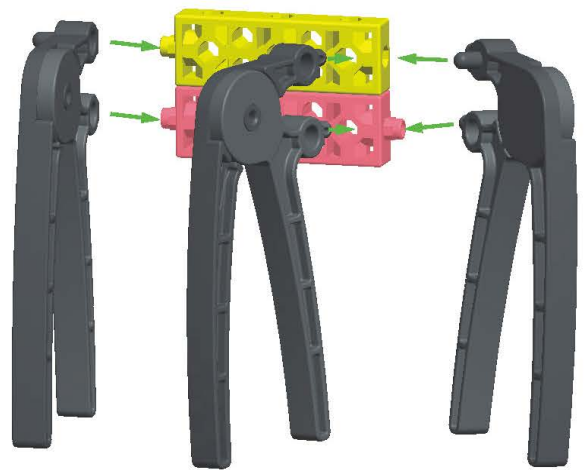

Example 1

Example 2

Example 3

Example 2

셀의 홈과 홈을 분리할 때

Example 3

셀의 홈과 돌기를 분리할 때

wireless remote controller 유선 리모컨



- 1 전원을 끈다.
- 2 (off)모드 스위치를 누른 상태에서 전원을 켜다.
- 3 (on)세그먼트창에 현재의 채널이 표시된다.
- 4 1번 or 3번 버튼을 눌러 채널을 변경한다.
- 5 4번 버튼을 눌러 채널설정완료.

※ 메인보드와 리모컨의 채널이 동일하게 설정되어야 합니다.



스파이더

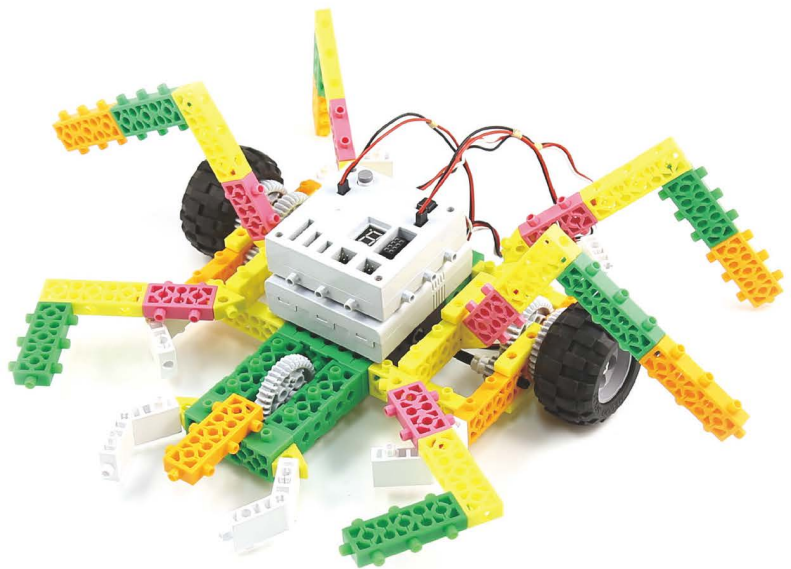

스파이더 | 구조물을 만들어봅시다.

Diamond H6 (2)	Diamond V8 (2)	Diamond V6 (2)	Rubi 8 (6)	Rubi 7 (7)	Rubi 4 (8)	Rubi 6 (2)	Rubi 0 (6)	Mini 2 (6)	Curve (6)	Triangle (8)	Link (6)	36톱니동근 기어(5)
12톱니동근 기어(2)	중간연결객 (4)	짧은연결객 (2)	오우보르드바퀴 (2)	A45 (3)	A64 (2)	6V건전지 케이스(1)	메인보드8M (1)	무선리모컨 (1)	DC모터 (2)	연결객 (1)		

1 ★★★

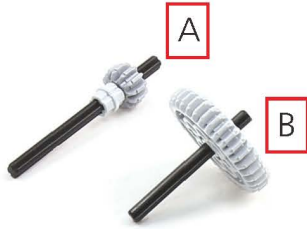

같은 모형 2개 만들어줍니다.



2 ★★★

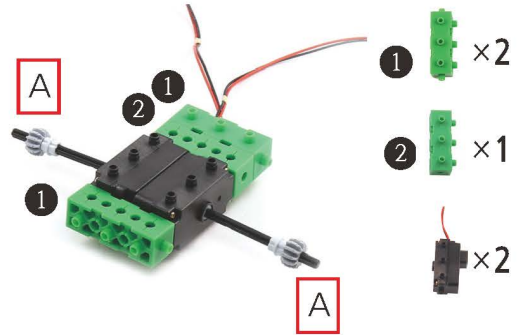

3 ★★★

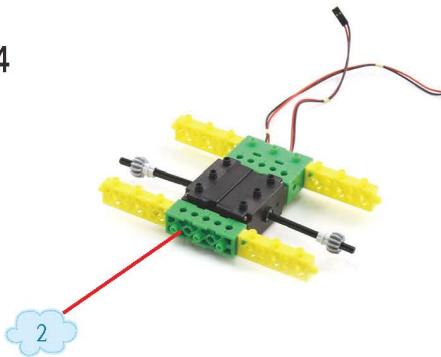

4 ★★★

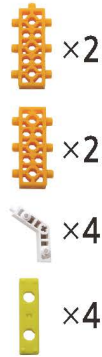

같은 모형 2개 만들어줍니다.

5 ★★★

5-1

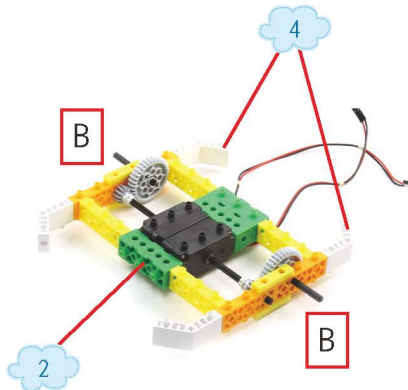





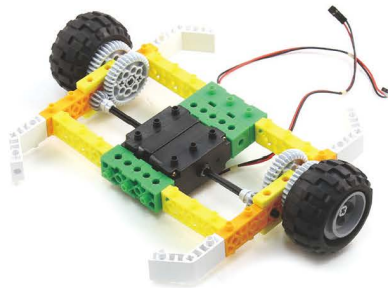



5-2

-  ×2
-  ×2
-  ×2



6 ★★★

6-1

-  ×1
-  ×2
-  ×2
-  ×1
-  ×2
-  ×2
-  ×1
-  ×2
-  ×1



6-2

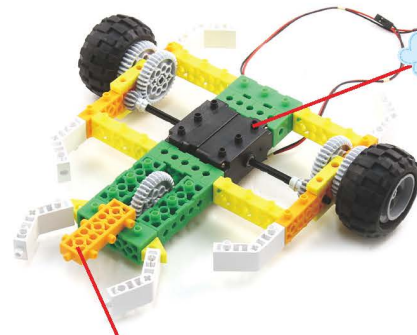

5-2

6-1

7 ★★★

7-1

-  ×4
-  ×2



7-2

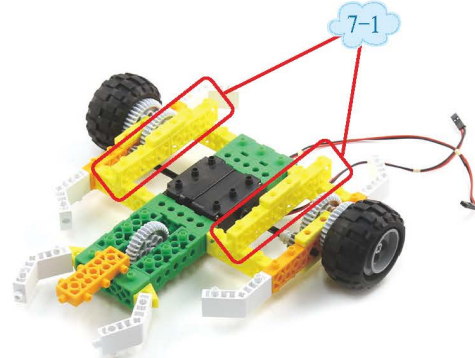

7-1

같은 모형 2개 만들어줍니다.

8★★★★

8-1

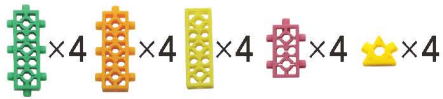
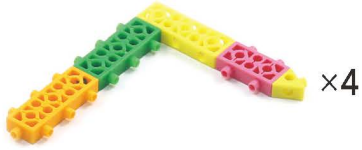

8-2

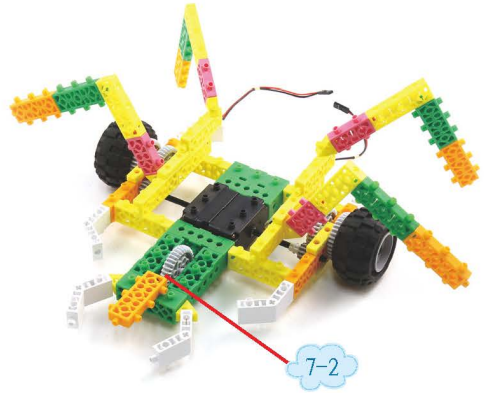

9★★★★

9-1

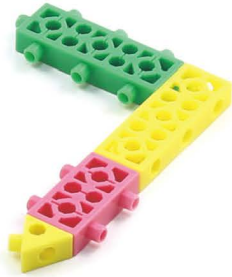
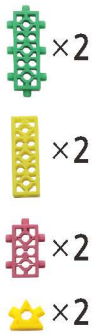

같은 모형 2개 만들어줍니다.

9-2

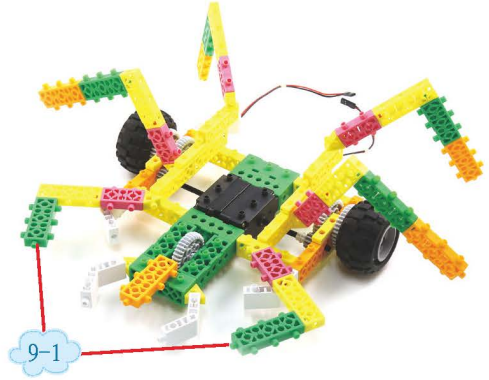

complete

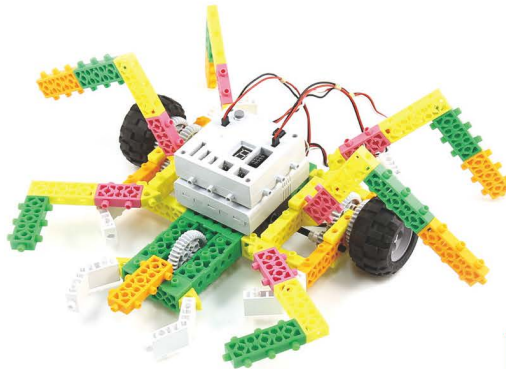

Mode
F