



메인보드 8M 연결 및 설치방법



세그먼트창

현재의 모드표시와 리모컨 설정을 위한 창



Remote receiver sensor 연결 (F, 7 MODE)

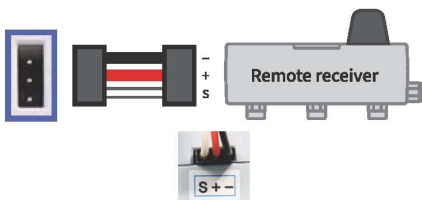

모터 연결



IR SENSOR (C MODE)



메인보드 모드설정방법

- 1 전원스위치를 누른다.
-전원 ON
- 2 모드스위치를 연속해서 누른다.
-모드변경
- 3 선택하려는 모드에서 3초간 기다린다.
-세그먼트 창이 3번 깜빡 거린다.
- 4 모드 설정 완료

메인보드 채널설정방법

- 1 메인보드의 전원을 끈다.
- 2 모드스위치를 누른 상태에서 전원스위치를 켜다.
- 3 세그먼트 창에는 현재 저장된 채널이 표시된다.
- 4 모드스위치를 눌러 채널을 변경한다
- 5 선택하려는 번호에서 3초간 기다린다.
-채널 설정이 완료되면 세그먼트 창이 깜빡 거린다.

Wired Remote controller 유선리모컨



분리도구 사용법

Example 1

셀의 돌기와 돌기를 분리할 때

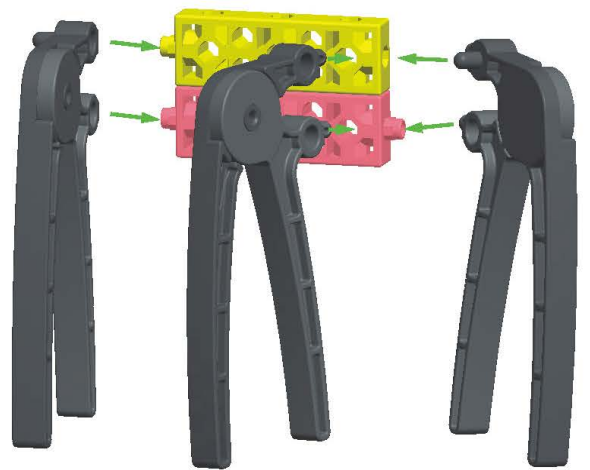

Example 1

Example 2

Example 3

Example 2

셀의 홈과 홈을 분리할 때

Example 3

셀의 홈과 돌기를 분리할 때

wireless remote controller 유선 리모컨



- 1 전원을 끈다.
- 2 (off)모드 스위치를 누른 상태에서 전원을 켜다.
- 3 (on)세그먼트창에 현재의 채널이 표시된다.
- 4 1번 or 3번 버튼을 눌러 채널을 변경한다.
- 5 4번 버튼을 눌러 채널설정완료.

※ 메인보드와 리모컨의 채널이 동일하게 설정되어야 합니다.



라인트레이서







라인트레이서 | 구조물을 만들어 봅시다.

Diamond H8 (1)	Diamond V8 (1)	Diamond V8 (3)	Diamond V6 (1)	Diamond V6 (1)	Rubi 8 (4)	Rubi 7 (6)	Rubi 6 (6)	Rubi 4 (4)	Rubi 2 (2)	Rubi 0 (7)	Mini 2 (6)	Mini 2 (3)
Link (6)	Triangle (6)	Curve (2)	36 톱니 동 근기어 (5)	12 톱니 동 근기어(2)	중간연결재 (2)	A45 (1)	A64 (2)	오프로드 바퀴 (2)	6V전원저 케이스(1)	메인보드 8M(1)	DC 모터 (2)	IR SENSOR (2)
연결재 (3)												

1 ★★★

1-1

-  ×1
-  ×1
-  ×1
-  ×2

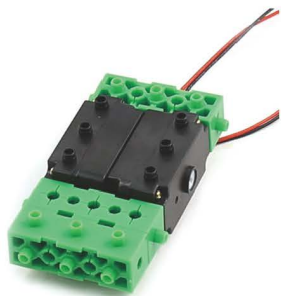

1-2

-  ×4

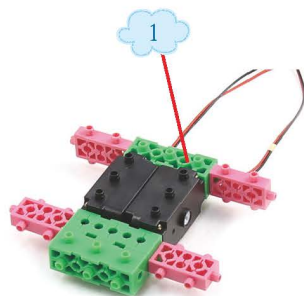

1-3

-  ×2
-  ×2
-  ×4





같은 모형 2개 만들어줍니다.

2 ★★★

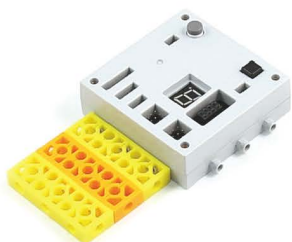
2-1



-  ×1
-  ×2
-  ×1

2-2

-  ×2



2-3

-  ×1
-  ×2

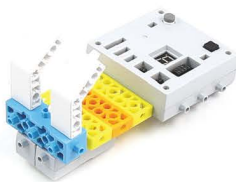

2-4

-  ×2
-  ×1
-  ×2
-  ×1
- A45



2-5

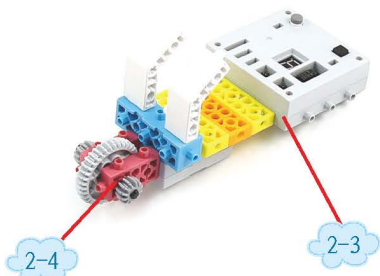

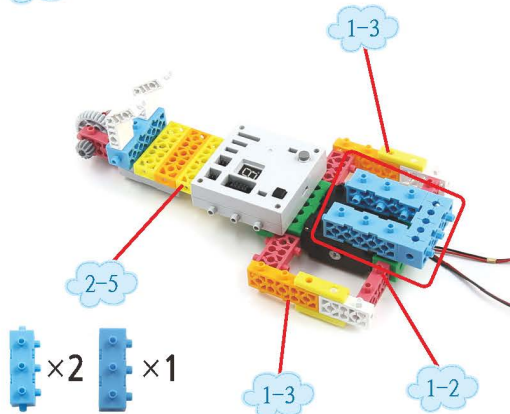

2-6



-  ×2
-  ×1

2-7

-  ×2
- A96
-  ×2

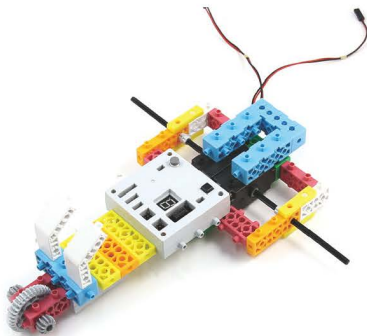







2-8

-  ×4
-  ×2





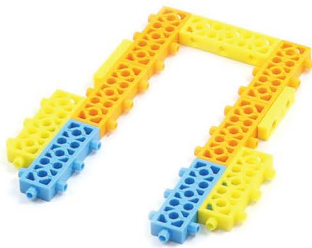

3 ★★★

3-1

-  ×2
-  ×2
-  ×2
-  ×1
-  ×2
-  ×2



3-2

-  ×2
-  ×2
-  ×2
-  ×4

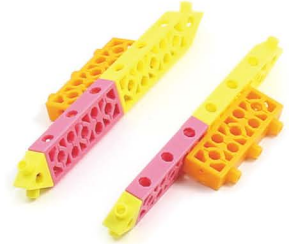

3-3



4 ★★★

4-1

-  ×1

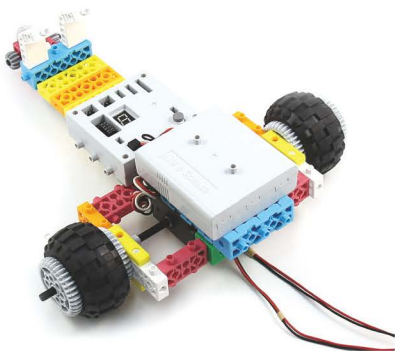

4-2

-  ×2
-  ×2

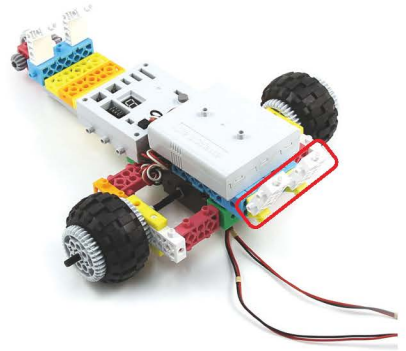

5****

 x2  x4  x2  x2

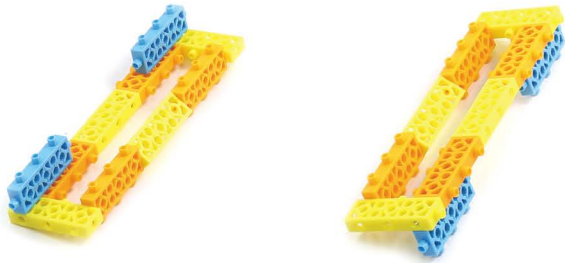

6****

6-1

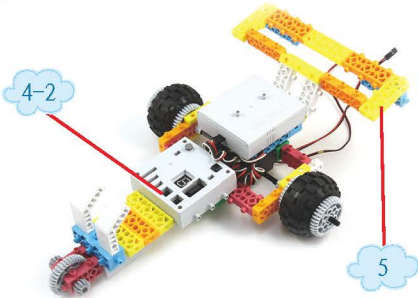

6-2

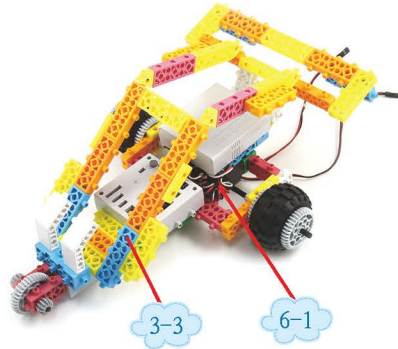

7****

 x3

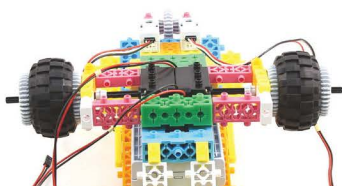
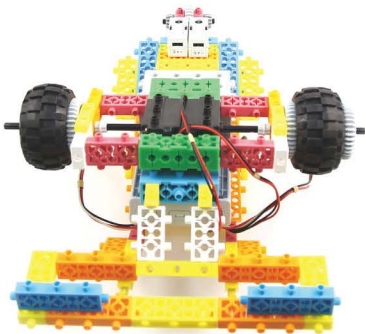

complete



Mode
9