

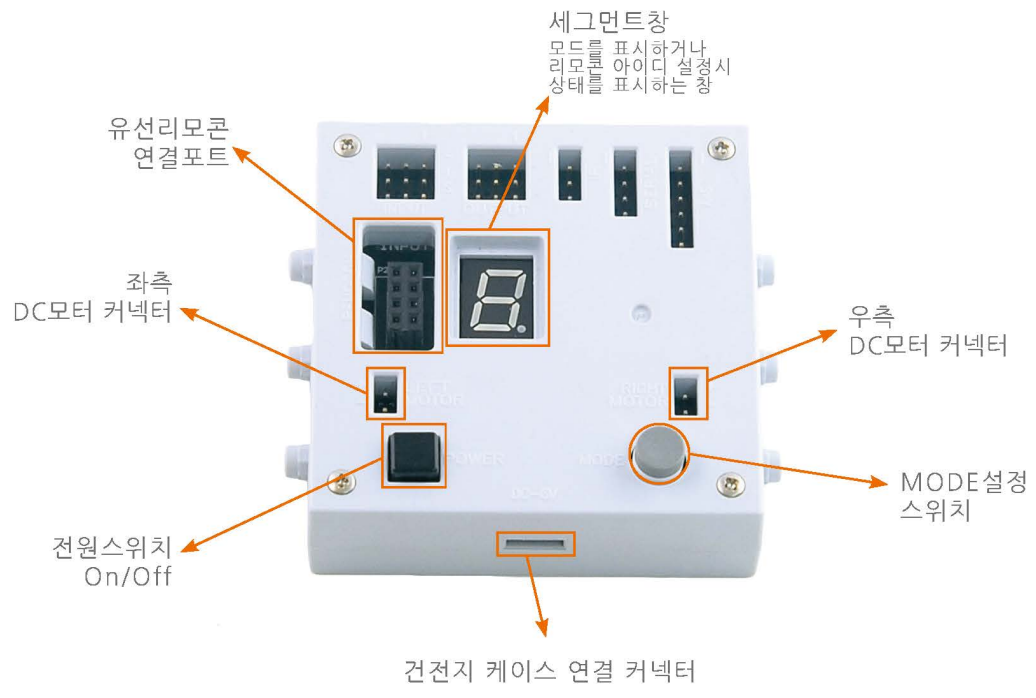

메인보드와 리모콘

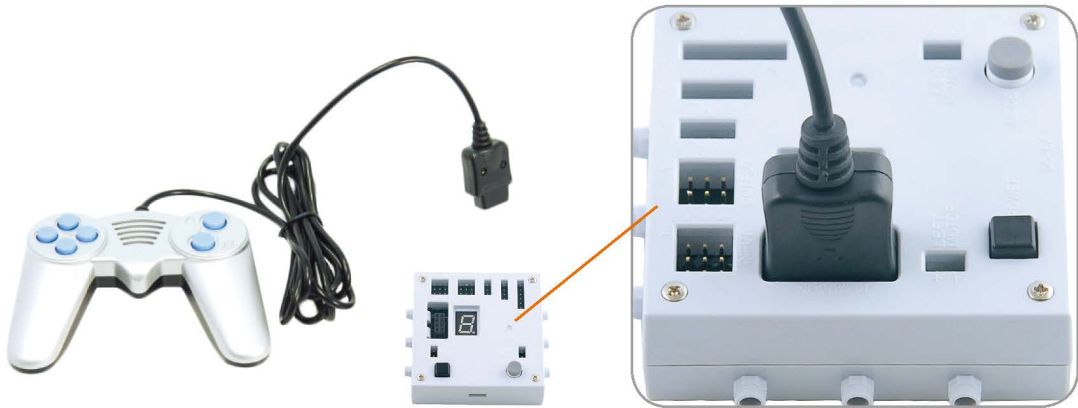

메인보드와 리모콘 연결방법



메인보드 동작모드(ID) 설정방법

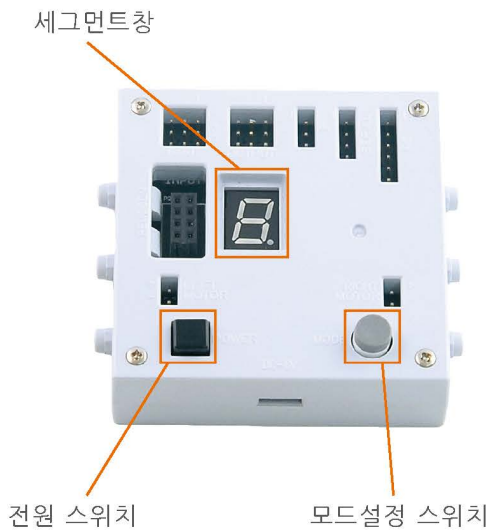

- ① 전원 켜짐(On)상태에서, 모드스위치를 한번 누른다.
(세그먼트가 3번 깜빡이면, 모드변경을 시작할 수 있다.)
- ② 모드스위치를 다시 누르면세그먼트 창이 숫자가 증가한다.
- ③ 선택하려는 번호에서 2초간 기다린다.
(3번 깜빡거림과 동시에 모드 설정이 완료된다.)



S에 연결커넥터를 흰색에서 빨강, 검정순으로 꽂아준다.

리모콘 수신 모듈과 연결 커넥터 조립법

연결커넥터를 검정색에서 빨강, 흰색순으로 꽂아준다.

메인보드와 연결 커넥터 조립법



리모콘채널 설정 방법



무선리모콘으로 로봇을 조정할 때 가까이에서 친구도 무선리모콘을 사용하고 있다면 신호의 간섭이 생겨 로봇이 오작동 할 수 있습니다. 리모콘 채널을 친구와 다르게 설정해두면 친구리모콘의 영향을 받지 않고 동작시킬 수 있습니다.

- 로봇축구경기 등 게임을 할때 주로 채널 설정을 해 줍니다.
- 메인보드 채널과 리모콘의 채널이 동일하게 설정되어야 합니다.

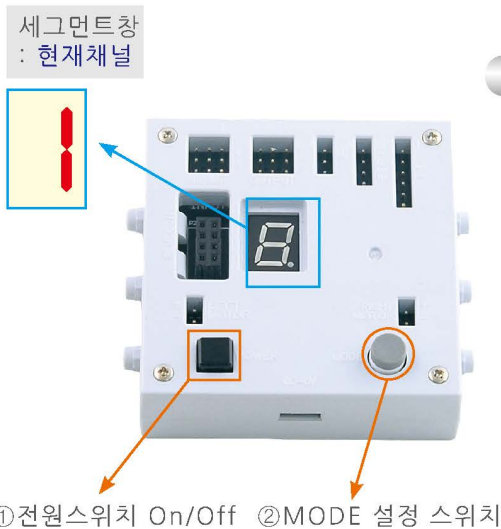

메인보드 채널 설정 방법

1. ①번 스위치가 Off(끔)된 상태
2. ②번 스위치를 누른 상태에서 ①번 스위치를 On(켄)
3. 세그먼트창에는 현재 저장되어 있는 채널 표시 (기본값으로 1이 세팅되어 있음)
4. ②번 스위치를 다시 눌러, 채널 변경
5. 원하는 채널로 이동 후, 2초간 대기
→세그먼트 3번 깜박이면, 채널 설정 완료



리모콘 채널 설정 방법

1. ①번 스위치가 Off(끔)된 상태
2. ②번 스위치를 누른 상태에서 ①번 스위치를 On(켄)
3. 세그먼트창에는 현재 저장되어 있는 채널 표시 (기본값으로 1이 세팅되어 있음)
4. 1, 3번 스위치를 (상/하) 눌러, 채널 변경
5. 원하는 채널로 이동 후, 4번 스위치를 눌러 저장



오토바이

웜기어와 D.C모터를 이용하여 오토바이의 앞바퀴를 좌우로 돌려 움직이게 할 수 있는 로봇입니다. 다른 모형의 오토바이도 만들어보세요.



오토바이 부품리스트 | 구조물을 만들어 봅시다.

굵은 돌기 수평셀 (3)	굵은 돌기 수평셀 (1)	굵은 돌기 직각셀 (1)	굵은 직각셀 (6)	8돌기셀 (5)	7돌기셀 (7)	4돌기셀 (4)	6돌기셀 (6)	2돌기셀 (9)	기본셀 (6)	2단셀 (7)	1단셀 (1)	굴절셀 (2)
삼각셀 (7)	8톱니 기어(1)	24톱니 기어(2)	베벨기어(2)	12톱니 기어(2)	36톱니 기어(5)	웜기어 (1)	짧은연결축 (4)	중간연결축 (8)	긴연결축 (1)	모터연결축 (1)	오프로드 바퀴(2)	축 14 (1)
축 64 (4)	축 96 (2)	배터리케이스(1)	DC모터 (2)	유선리모컨 (1)	메인보드 (1)	연결축 (1)						



1 ★★★

1-1

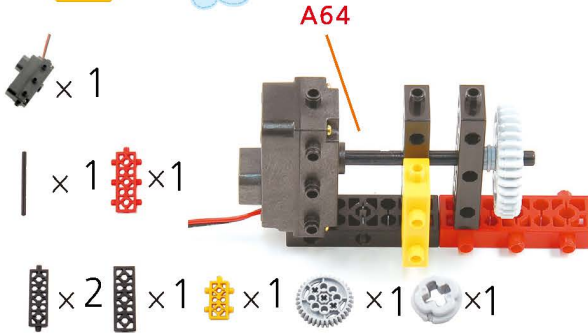

1-2

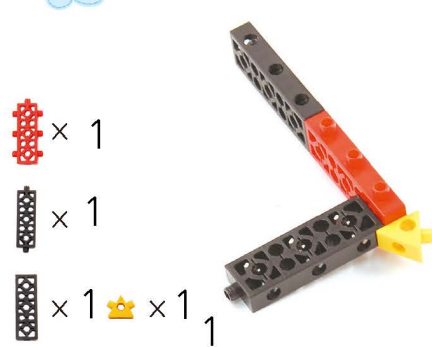

1-3

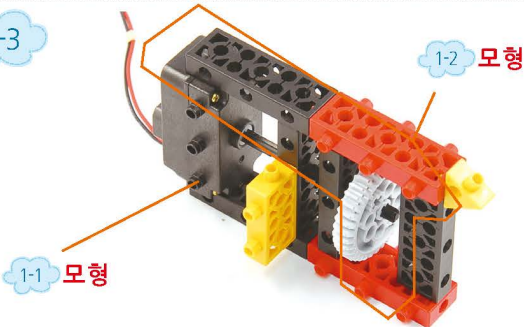

1-4



그림 1-1번과 1-2번에서 만든 모형과 조립합니다.

1-5

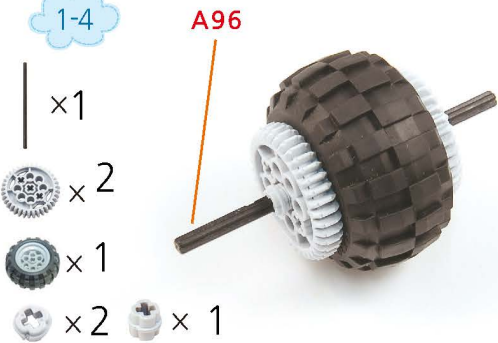
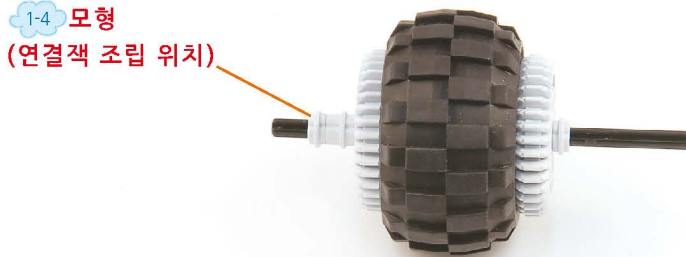

2 ★★★

2-1

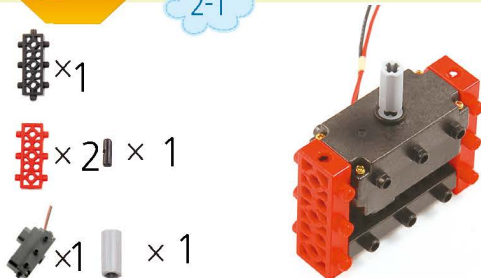

2-2

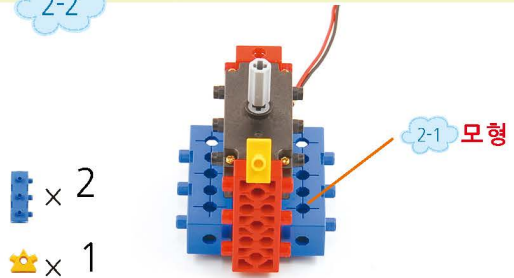



2***

2-3

- × 2
- × 2

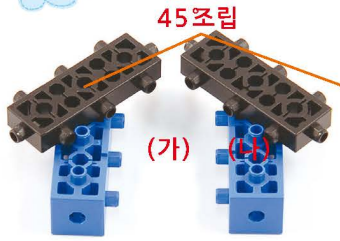

2-4

2-3 (가) 모형

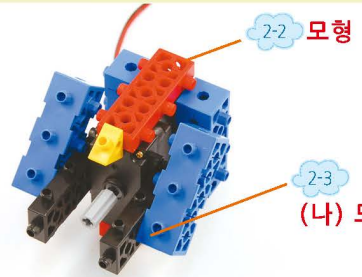

3***

3-1

2-4 모형



3-2

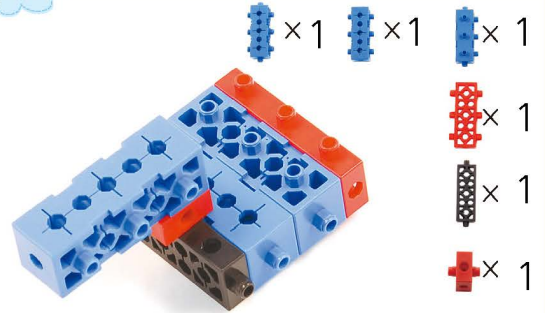

3-3

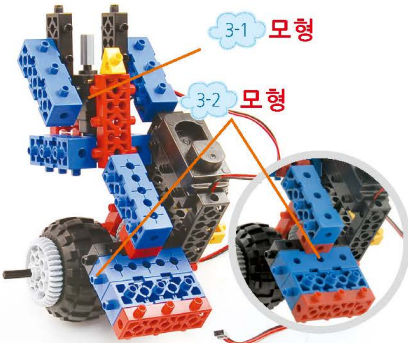

3-4

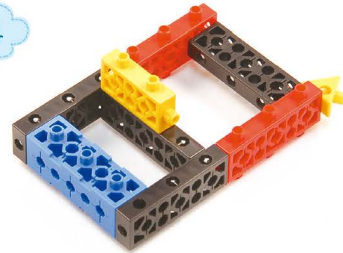

- × 1
- × 2
- × 2
- × 2
- × 1
- × 1

3-5

앞모습

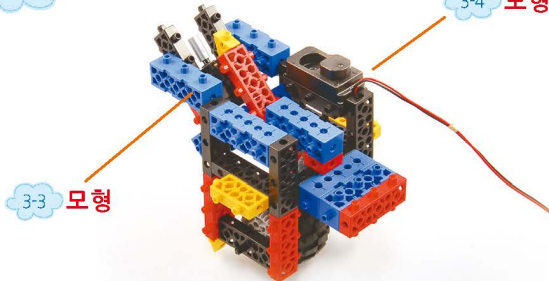

측면

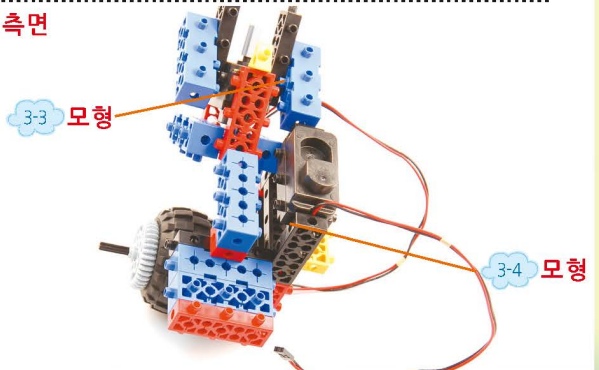



4***

4-1



4-2

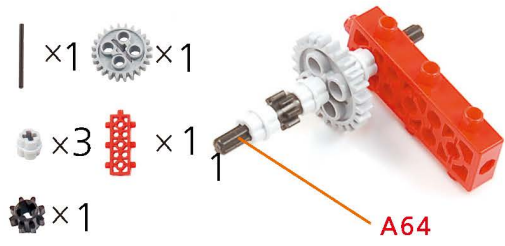

5***

5-1



5-2

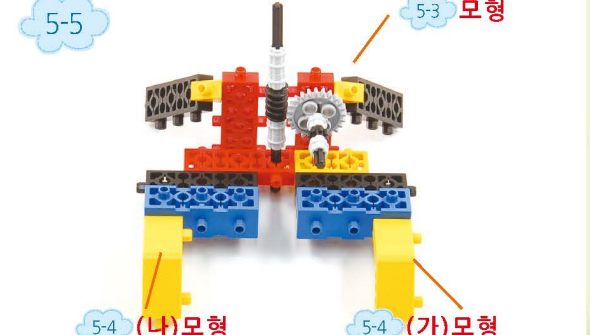
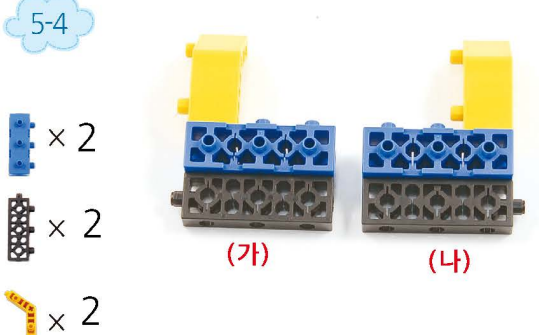
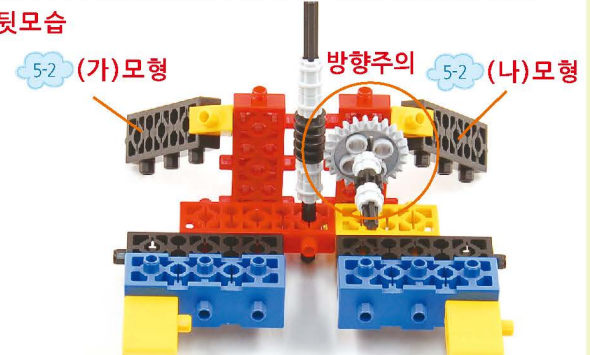
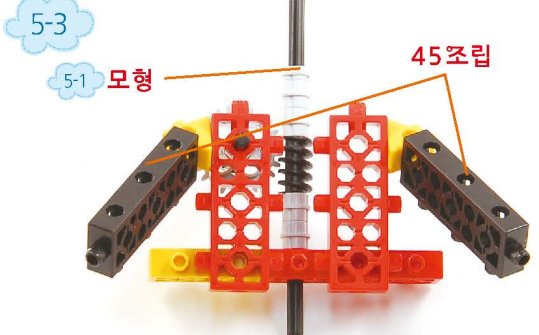



오토바이

6***

6-1

| × 1

× 1

× 1

× 2

× 1

× 1

× 2

A64



6-2

× 1

× 1

× 2

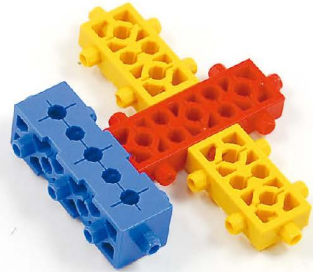

6-3

6-2 모형

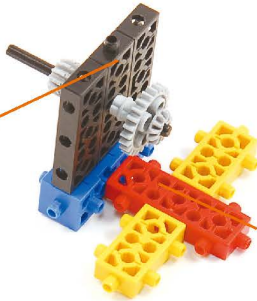

6-1 모형

6-4

6-3 모형

조립위치주의

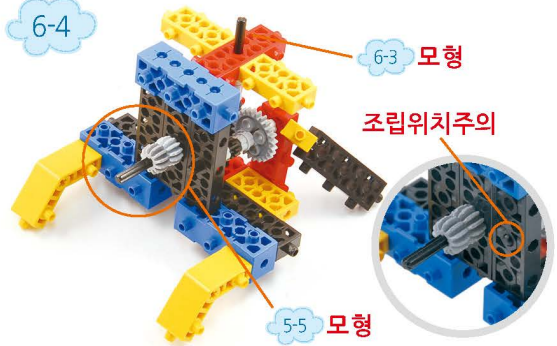

5-5 모형

6-5

6-4 모형



3-5 모형

6-4 모형

3-5 모형

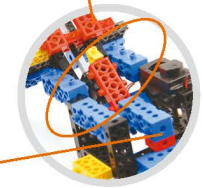

7***

7-1

× 2

× 2

× 2

× 2



같은 모형 2개를 만들어줍니다.

7-2

× 1

× 2

× 1





7***

- × 1
- × 1
- × 1

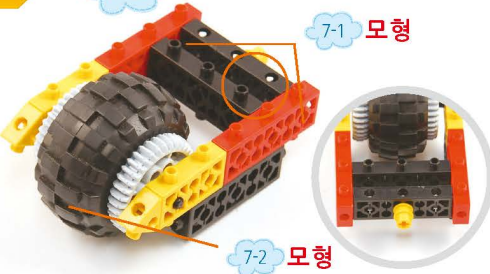

7-4

7-3 모형

6-5 모형



8***

8-1

- × 1
- × 1
- × 1



메인보드 연결방법 및 설정

※ 동작모드설정



유선리모콘
연결포트

세그먼트창
모드를 표시하거나
리모콘을 아이디 설정시
상태를 표시하는 창

좌측
DC모터 커넥터

우측
DC모터 커넥터

전원스위치
On/Off

MODE설정
스위치

건전지 케이스 연결 커넥터

