

TORI BLOCK 슛토리 1인용



고객지원
www.robotori.com



부품리스트

헤비셀

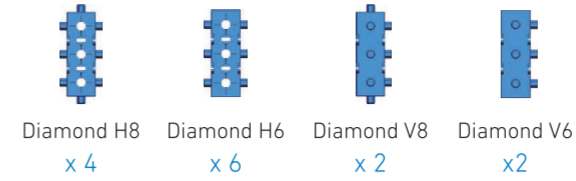

기어&연결잭



라이트셀

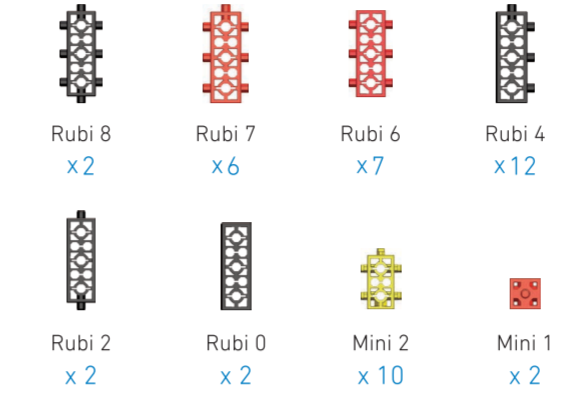

전자부

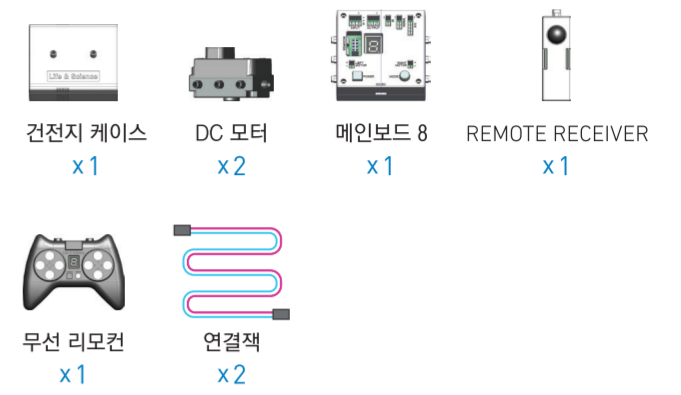

특수셀

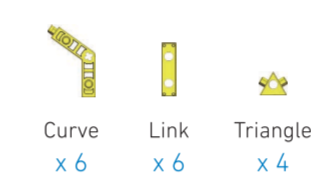

축

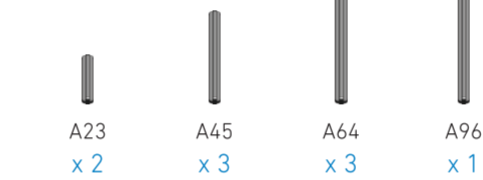

바퀴



분리도구



분리도구 사용법

- EXAMPLE 1 셀의 돌기와 돌기를 분리할 때
- EXAMPLE 2 셀의 홀과 홀을 분리할 때
- EXAMPLE 3 셀의 홀과 돌기를 분리할 때

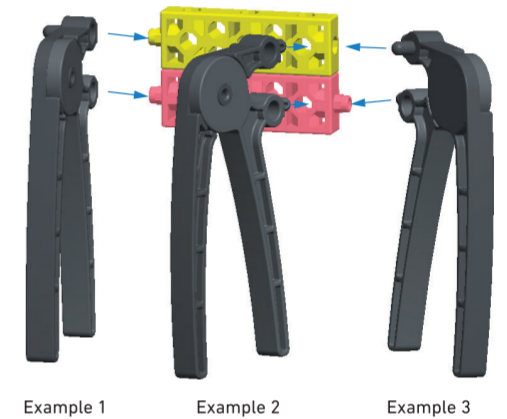

메인보드 MAINBOARD

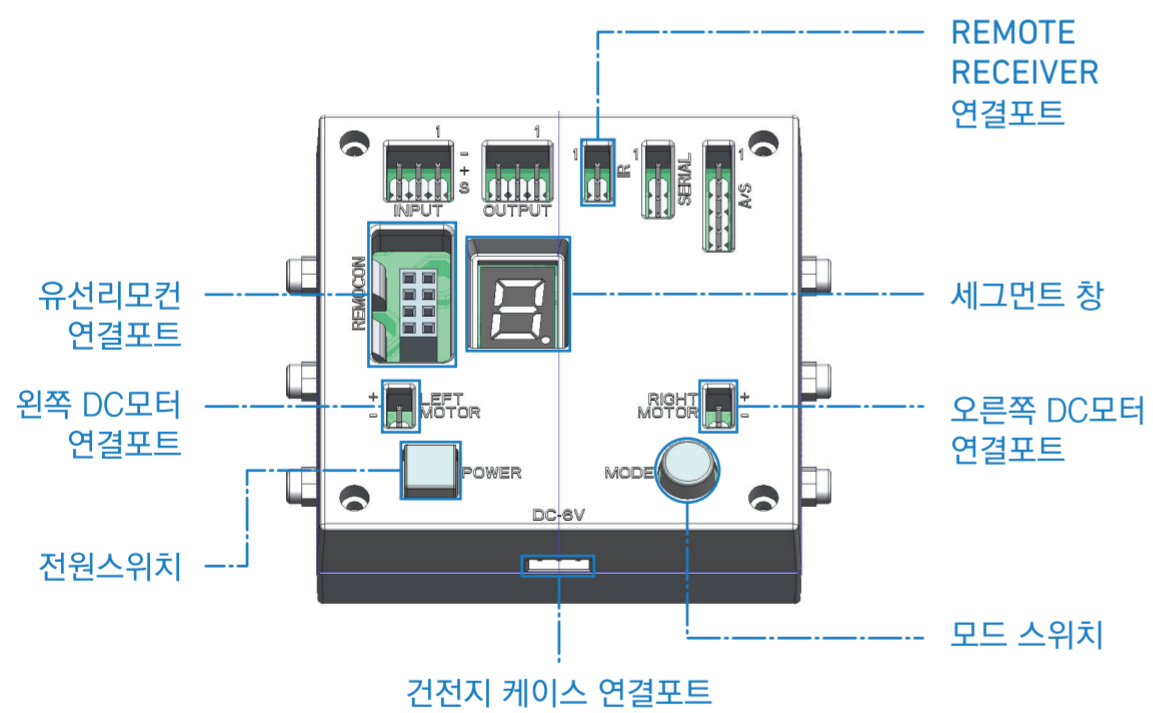

무선 리모컨



연결 및 설정방법

1 메인보드, DC모터, 건전지 케이스, REMOTE RECEIVER를 그림1을 참고하여 연결한다.

2 메인보드의 동작모드를 'F'로 설정해준다.

메인보드 모드 설정방법

- 전원스위치를 눌러 전원 ON.
- 세그먼트 창에 F 가 뜰 때까지 모드스위치를 연속으로 누른다.
- 2초간 대기 후 세그먼트 창이 3번 깜빡이면 F 모드로 설정이 완료된다.

* 무선리모컨 사용시에는 'F' 모드로 설정하여야 한다.

3 메인보드와 무선리모컨의 채널을 동일하게 설정해준다.

메인보드 채널 설정방법

- 전원을 OFF 한다.
- 모드스위치를 누른 상태에서 전원 스위치를 누르면 세그먼트 창에 현재 저장되어 있는 채널이 표시된다.
- 원하는 채널이 나올 때까지 모드 스위치를 연속으로 누른다.
- 세그먼트 창에 채널을 확인 후 2초간 대기하면 세그먼트 창이 3번 깜빡이면서 채널설정이 완료된다.

* 메인보드 모드 설정과 채널 설정을 혼동하지 않도록 합니다.

그림1

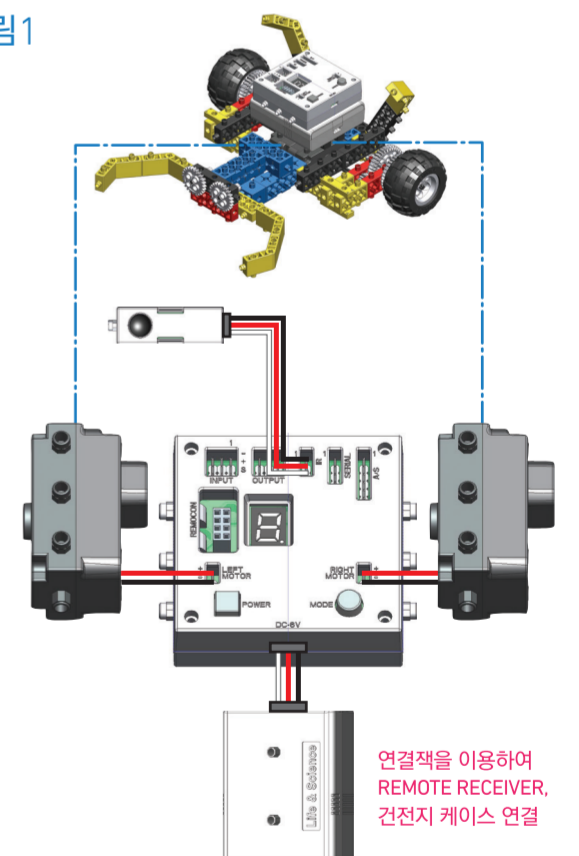

무선 리모컨 채널 설정방법

- 전원을 OFF 한다.
- 모드스위치를 누른 상태에서 전원 스위치를 누르면 세그먼트 창에 현재 저장되어 있는 채널이 표시된다.
- 1번 또는 3번 버튼을 연속으로 눌러 채널을 변경한다.
- 세그먼트창에 원하는 채널이 표시되어 있는 상태에서 4번 버튼을 누르면 채널 설정이 완료된다.

조립도

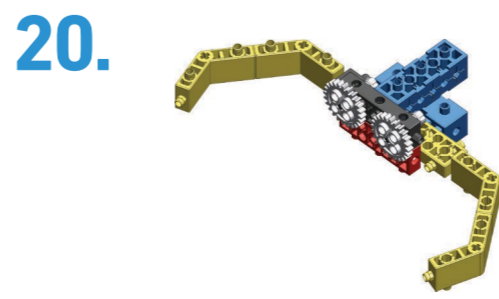
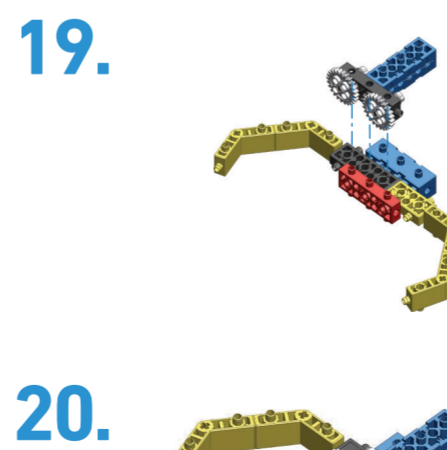
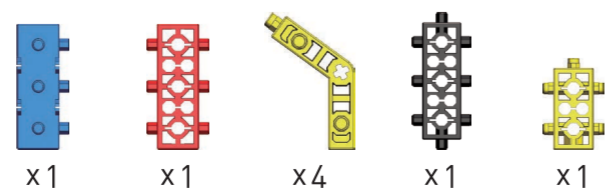
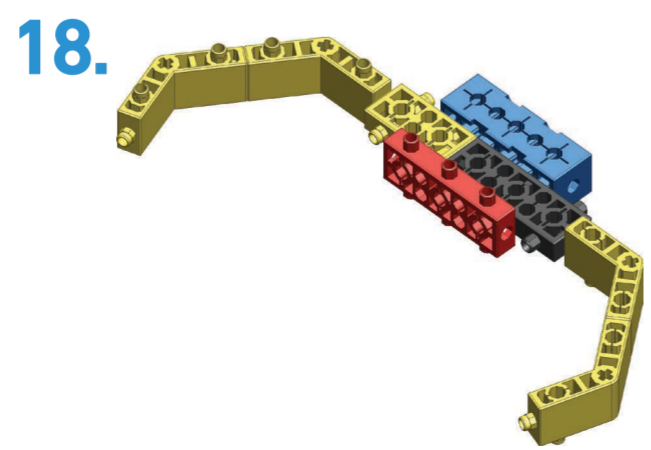
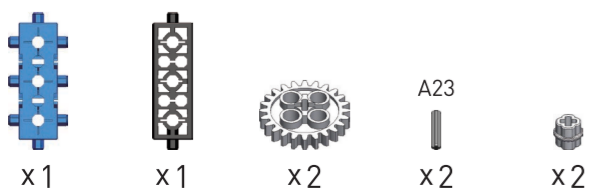
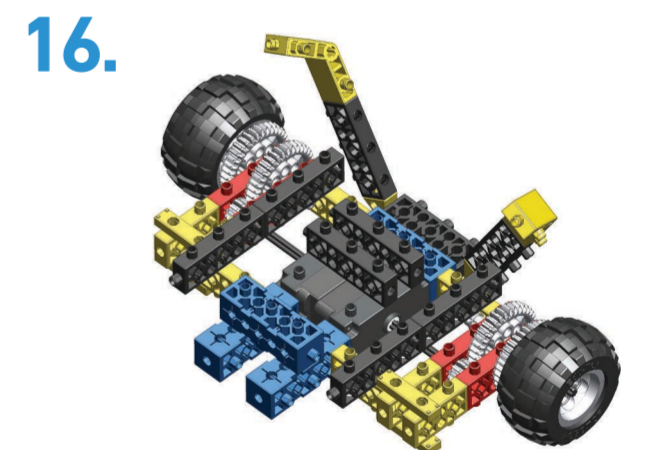
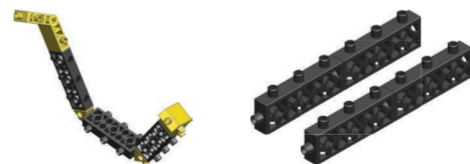
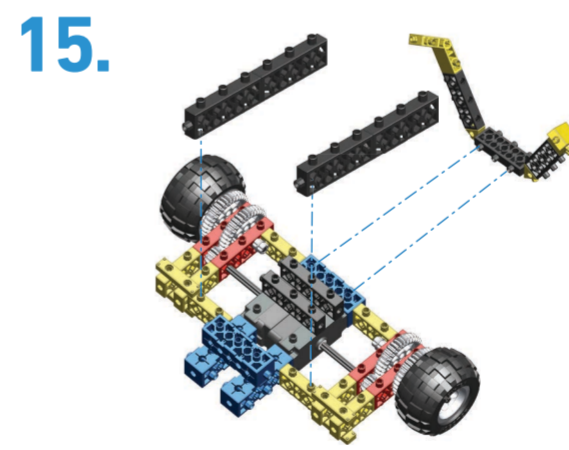
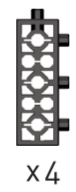
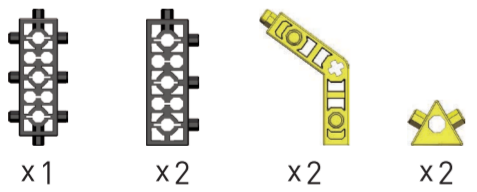
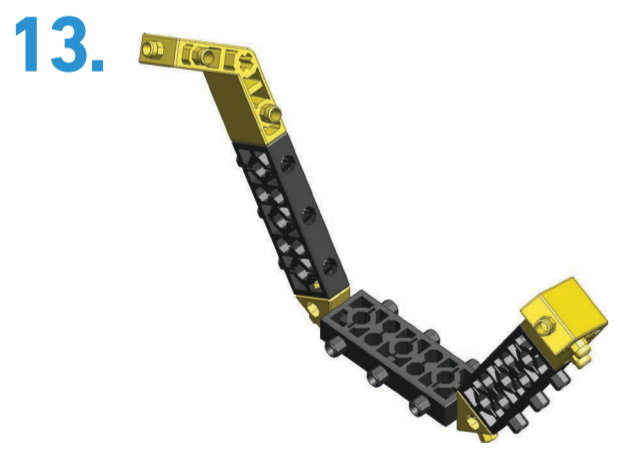
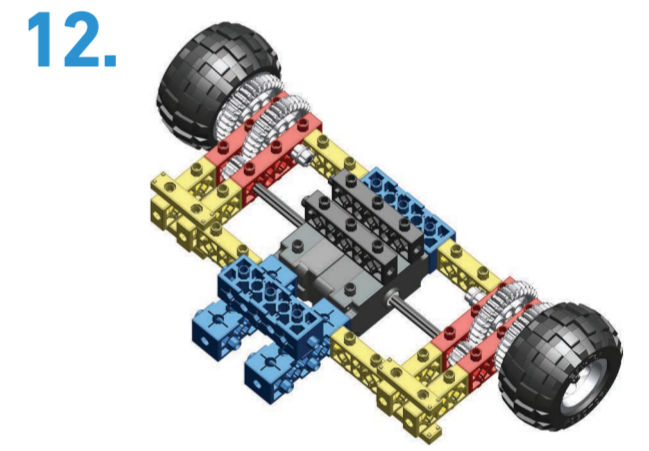
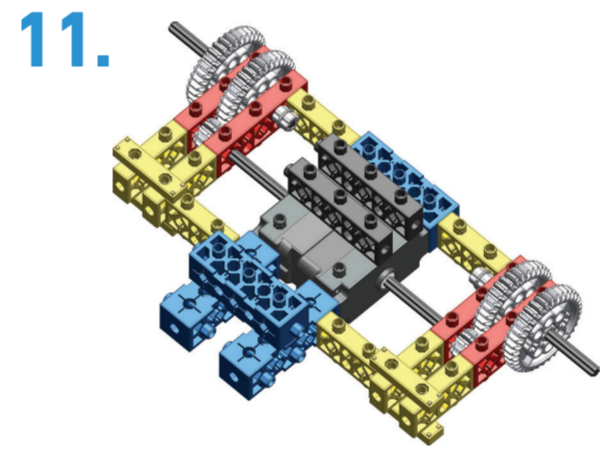
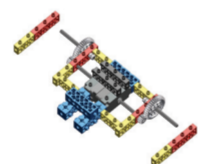
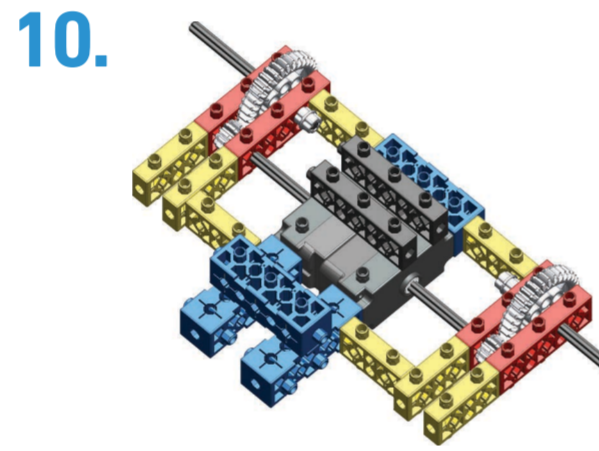
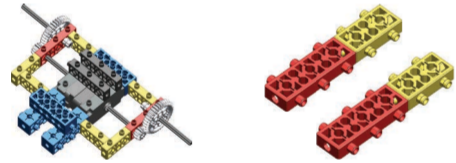
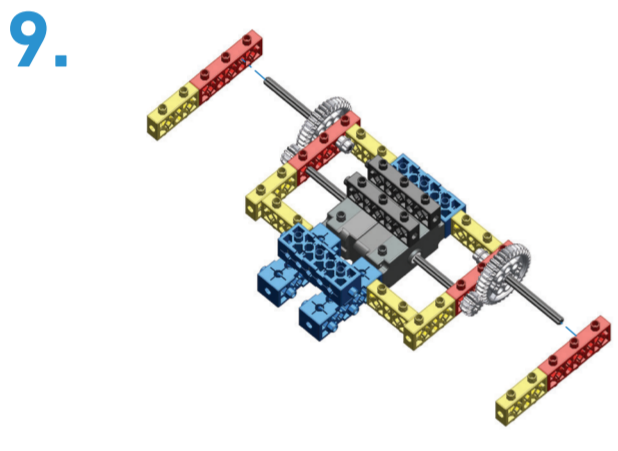
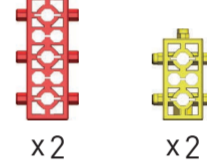
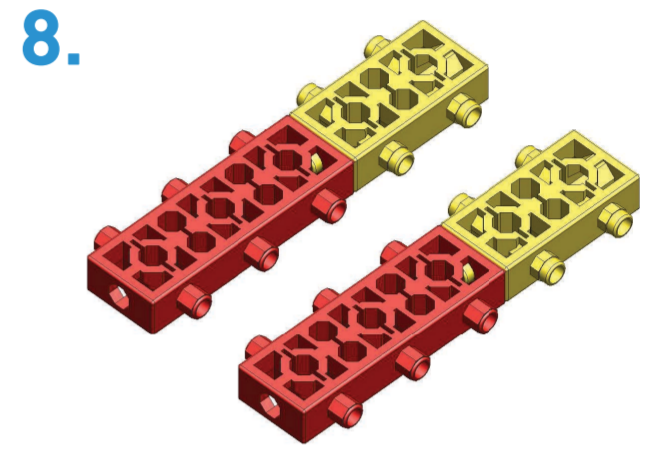
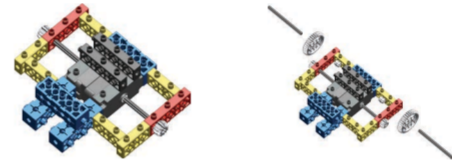
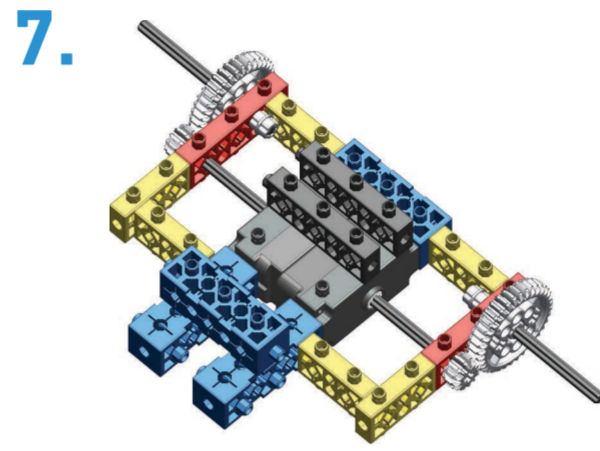
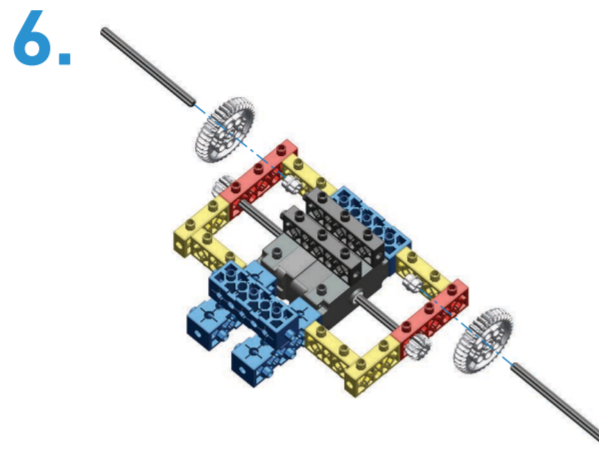
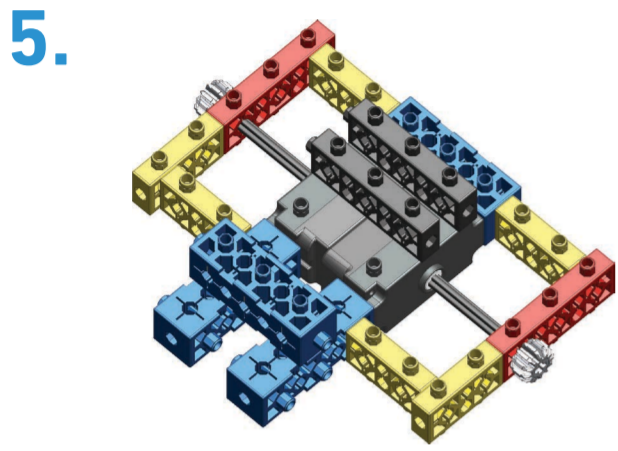
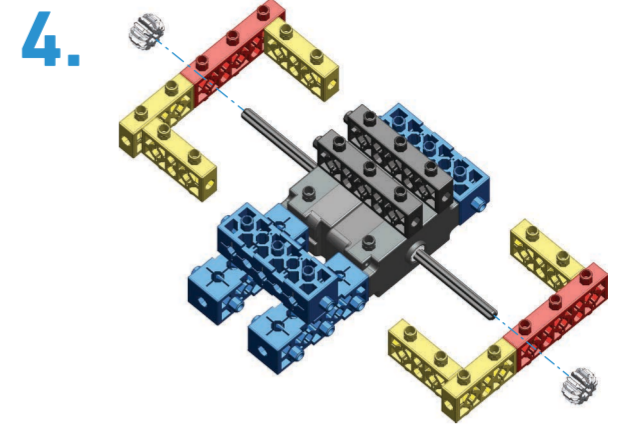
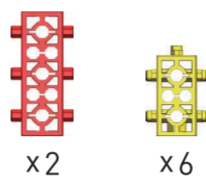
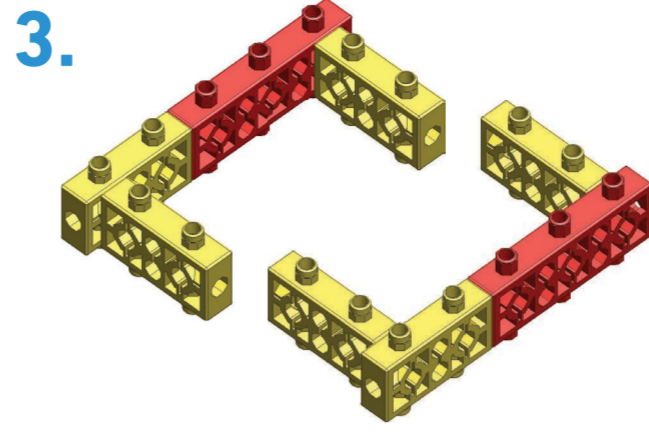
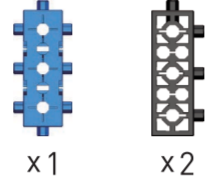
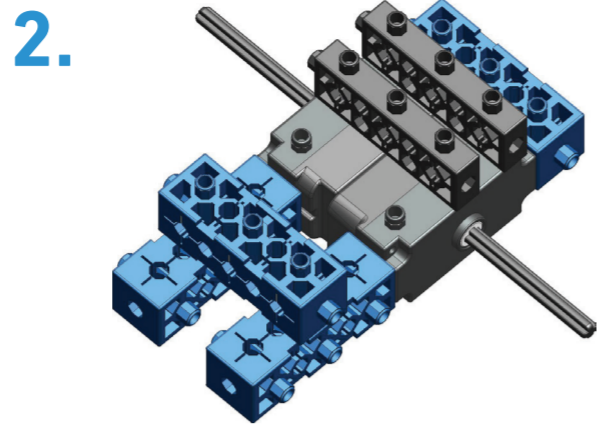
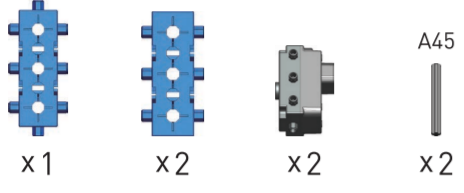
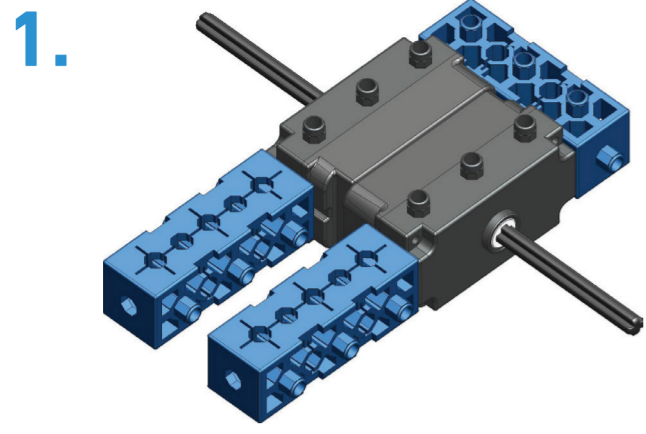

완성

