

Introduction to ROKIDS Plus and the Electronics

Chapter 1

What is ROKIDS Plus?

ROKIDS Plus is a mobile app that lets you study coding in-depth by using a variety of buttons and sensors. Using basic coding, you'll be able to send commands to your robot to make it move forward, backward, left or right using DC motors.

In addition to this, you'll also be able to program your creations to various other things, like blink a light, react to light and darkness, and even both of those at the same time! You'll even be able to program your creations to play music.

The ROKIDS app is available for free download in that Apple App Store. Simply search for ROKIDS Plus! Note: Make sure to download ROKIDS Plus, not ROKIDS.

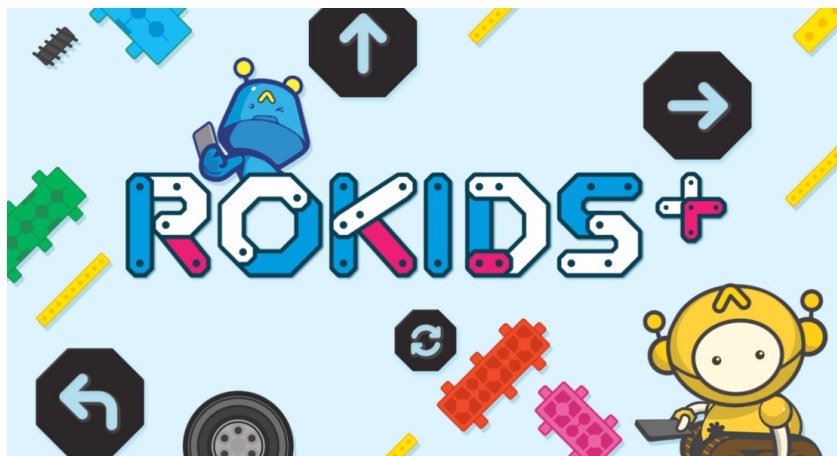

Introduction to the Mainboard

The mainboard is essentially the brain that controls the robot. Without the mainboard, your robot will be unable to function. This board enables the robot to move when it receives commands via the mobile app or Bluetooth.

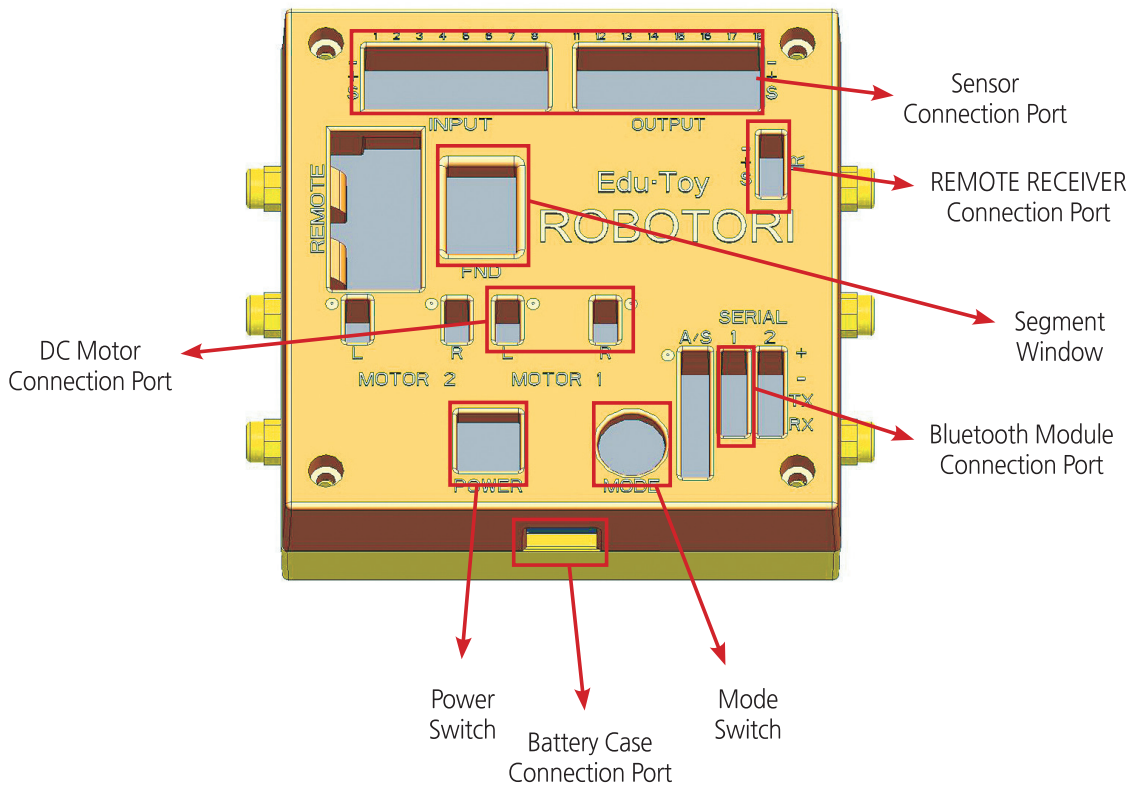

- Power Switch: Turns on or off the power
- Mode Switch: Changes the mode
- Segment Window: Displays operation mode for mainboard
- Battery Case Connection Port: Connects to the battery case
- Bluetooth Module Connection Port:: Connects to Bluetooth module
- Sensor Connection Port: Connects to Sensors
- DC Motor Connection Port: Connects to DC Motor

Introduction to the Battery Case

The battery case supplies the mainboard with power using the connection jack. You can turn on the power by pressing the power switch after connecting the battery case.

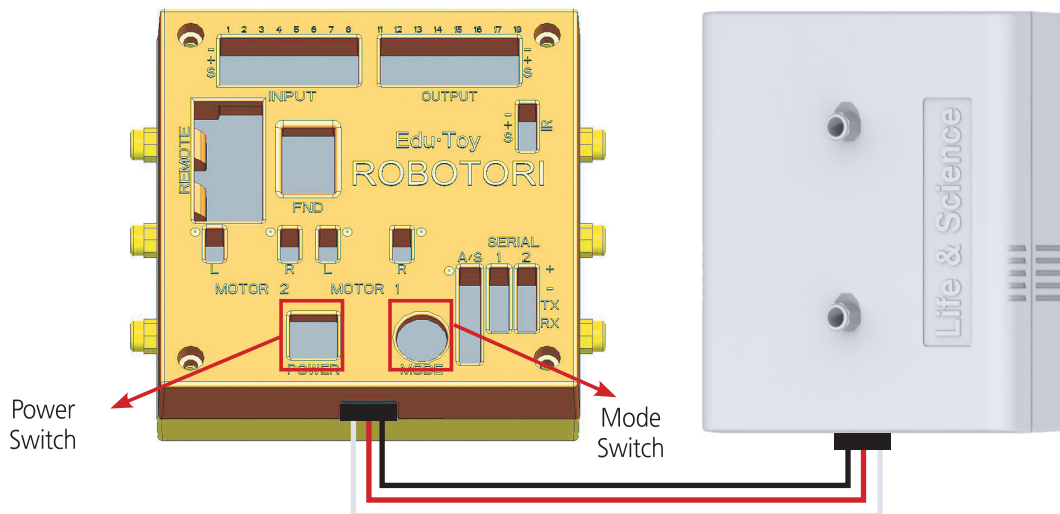

※ How to Set the Mode on the Mainboard

Setting the mode on the mainboard is simple. Each of the mainboard modes has its own special function, but only one will be important when using ROKIDS Plus.

1. Power on the mainboard and press “Mode” switch multiple times.
2. If “J” is displayed on the segments window, pause and wait for the LED to stop blinking.
3. After the screen blinks three times, the mainboard will be set to whichever setting is displayed.

※Caution : When using the ROKIDS Plus app, make sure that your mainboard is set to “J”!

Introduction to the Bluetooth Module

This module connects the mobile app to the robot. This is how you control the robot from the app, don't forget to include it in your build!

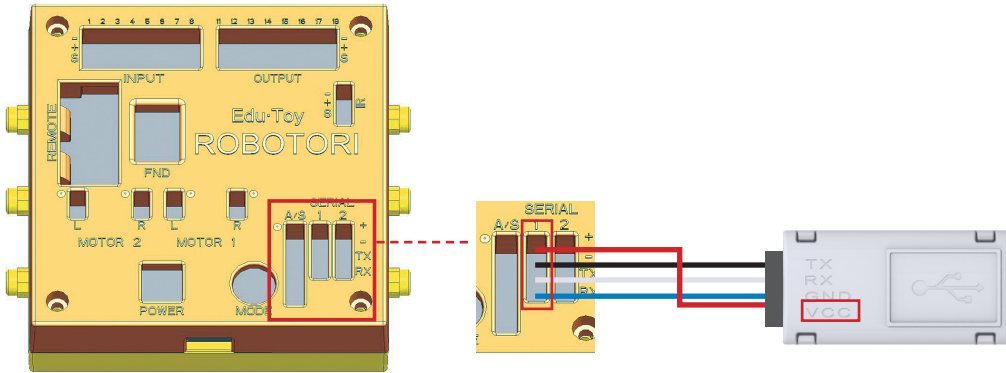

Introduction to Sensors

A sensor will input or output signal to or from the mainboard. For example, there is a sensor that detects light, but there's also a sensor that outputs an LED light.

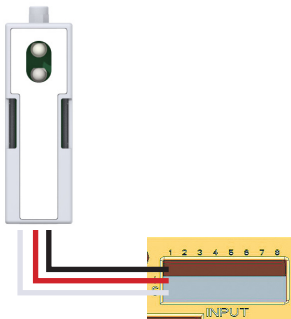
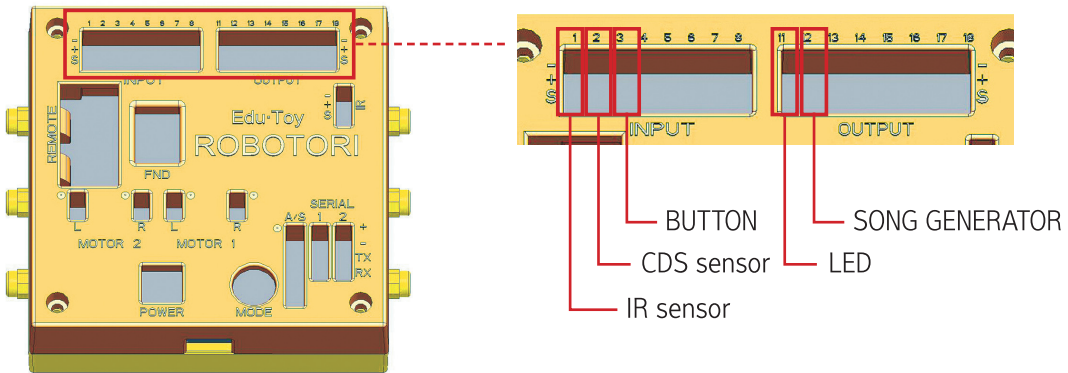

When connected into the sensor, the wires should be arranged:
White - Red - Black
When connected into the mainboard, the wires should be arranged:
Black - Red - White

Remember: Always connect sensors and the mainboard so that the white cable is always in the S-slot.

Installing the ROKIDS Plus App

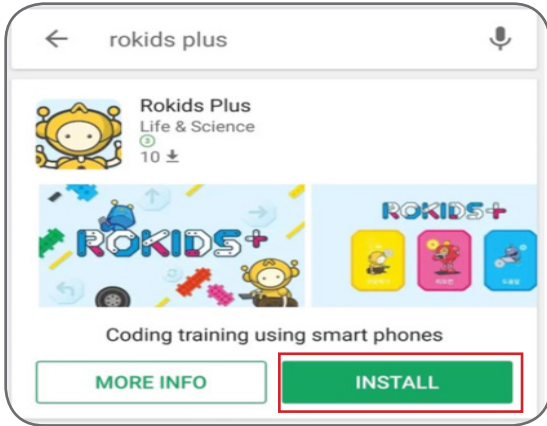

1. Search 'ROKIDS Plus' from the Apple App Store

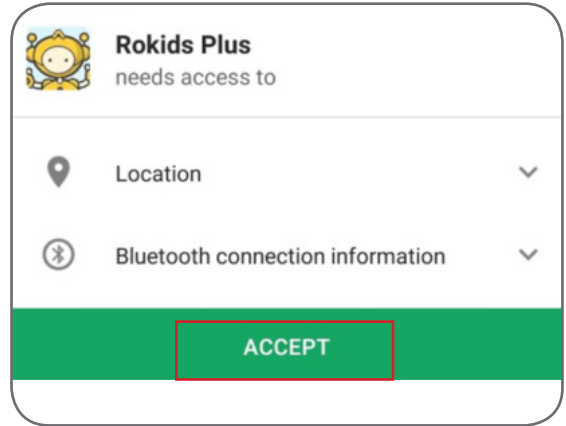

2. Confirm and install the app

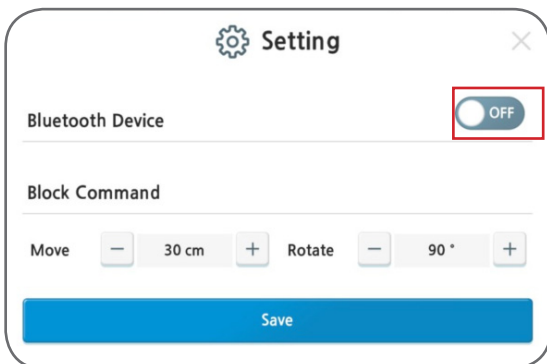

3. Turn on the Bluetooth in the settings menu by pressing the button in the top corner of the app

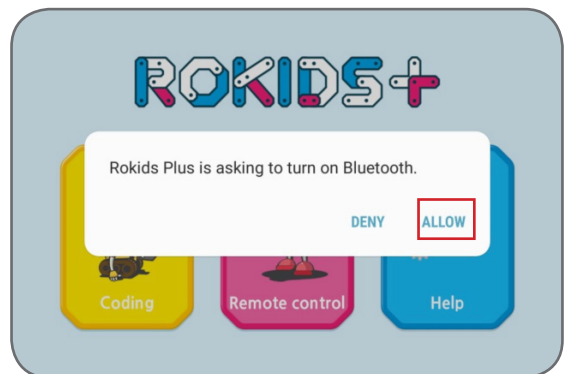

4. Activate the Bluetooth function

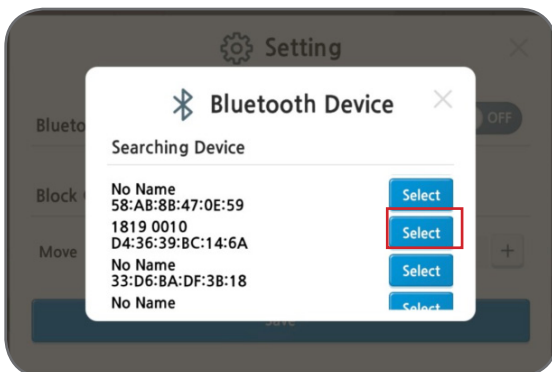

5. Make sure that the correct Bluetooth module is synced up to the ROKIDS Plus app

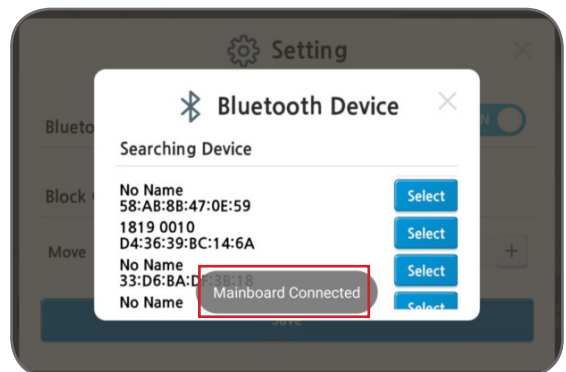

6. The Bluetooth connection should be complete

HOME MENU OPTIONS



Coding: This is the menu you use for “free” coding

Remote Con: This menu allows you to adjust the robot’s position, forward backward, left or right using a remote control

Help: This menu will help explain how to use the ROKIDS Plus app

Learning the ROKIDS Plus Menu

The screenshot shows the ROKIDS Plus app interface. At the top is a navigation bar with icons for Home, Setting, File, Clear, ROKIDS+ logo, IR, CDS, Button, and a play button. Below this is the Coding Area, which contains four dashed octagonal slots. At the bottom is the Command Area, which contains seven octagonal buttons: a green up arrow, a blue down arrow, a pink left arrow, a yellow right arrow, a grey pause button, and a purple refresh button. Red arrows point from text descriptions to these elements.

Home Icon: This will take you back to the home screen of the app

Setting Icon: This is where you make sure your robot is connected to the Bluetooth. In addition, this is where you adjust the values for the Move and Rotate commands

File: This is where you’ll save and retrieve coding data you’ve made

Clear: This will delete your commands

IR Sensor Icon: This will take you to the IR menu

CDS Sensor Icon: This button will take you to the CDS menu

Button Icon: This will open the button menu

Coding Area : This is where you will drag and drop the icons from the Command Area. One code fits in each slot, and the codes will always be executed from left to right

Command Area : This is where you can find all the commands that you can make your creation perform

Learning the ROKIDS Plus Menu



Forward Button:
Commands your robot to move forward



Backward Button:
Commands your robot to move backward



Left Rotation Button:
Commands your robot to turn left, counter-clockwise



Right Rotation Button:
Commands your robot to turn right, clock-wise



Repeat Button: Commands your robot to repeat a specified set of commands



Pause Icon: Commands your robot to halt for a set period of time.



Turn On LED Button: When the LED Sensor is installed, this will turn the LED on



Turn Off LED Button: When the LED Sensor is installed, this will turn the LED off



Turn On Song Generator:
When the Song Generator is installed, this will turn the Song Generator on



Turn Off Song Generator:
When the Song Generator is installed, this will turn the Song Generator off



Finish Button: Commands your robot to stop performing whatever actions are programmed.

The Mixer

Chapter 6

05



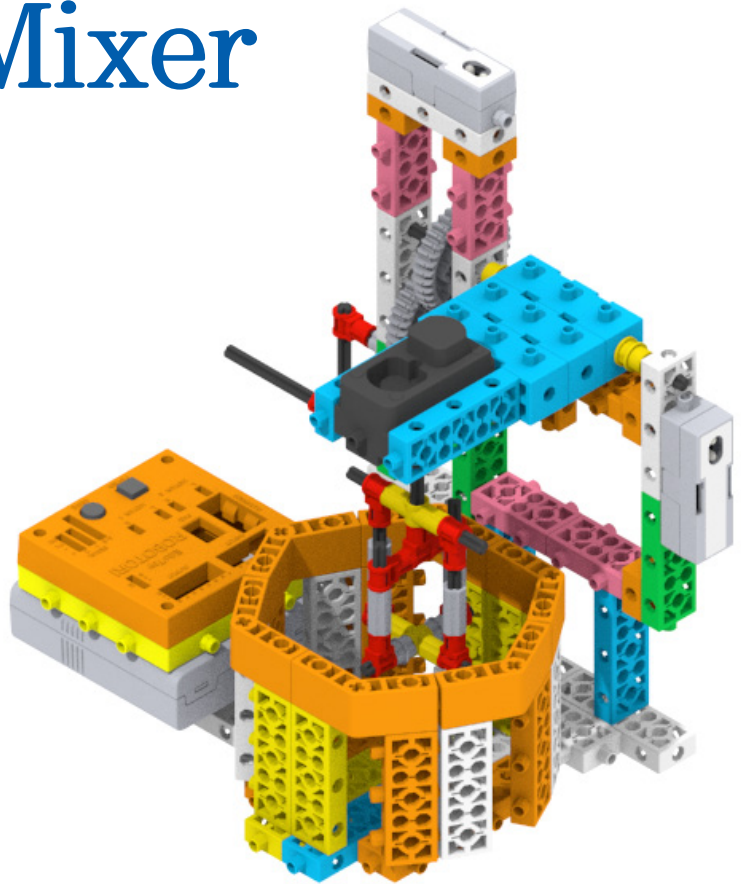



Mixer



Assembling the Mixer

Diamond V6 (3)	Rubi 4 (6)	Rubi 6 (2)	Rubi 2 (5)	Rubi 2 (3)	Rubi 0 (14)	Mini 2 (7)	Mini 2 (4)	Mini 2 (2)	Mini 1 (6)	Curve (6)	Sawtooth 12 (2)	Sawtooth 36 (2)
Middle Connector(6)	Long Connector(4)	Vertical Connector(11)	Motor connector(2)	180 Connector(2)	A14 (6)	A23 (8)	A45 (6)	A64 (1)	DC motor (1)	BUTTON SENSOR (1)	LED SENSOR (1)	Connector (3)
Battery case (1)	Bluetooth module (1)	Main board (1)										

1

-  x2
-  x2
-  x1
-  x2
-  x1
-  x1
-  x3

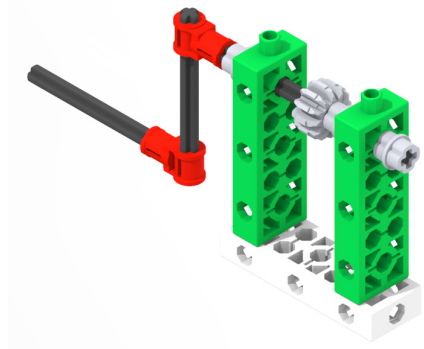

2

-  x3
-  x2
-  x2
-  x1
-  x2
-  x1
-  x2
-  x1

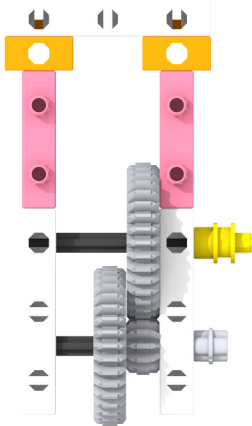
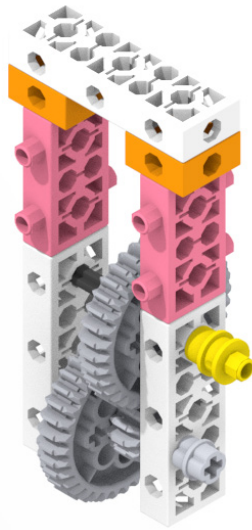

3

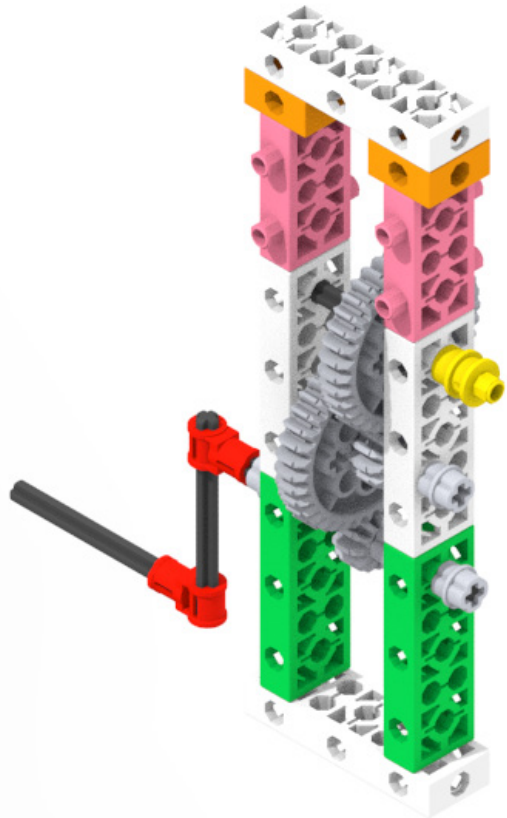

4

 x2

 x2

 x1

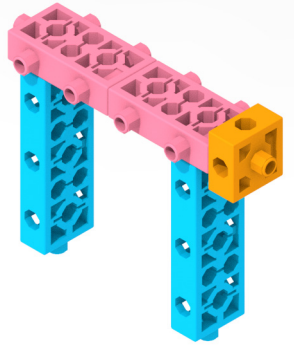

5

 x1

 x1

 x1

 x2

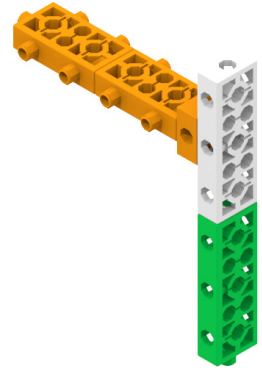

6

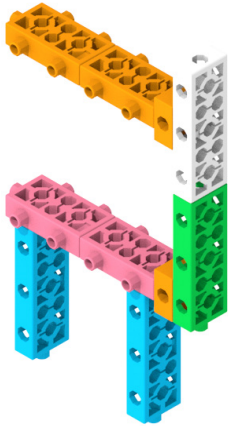

7

 x3

 x1

 x1

 x1

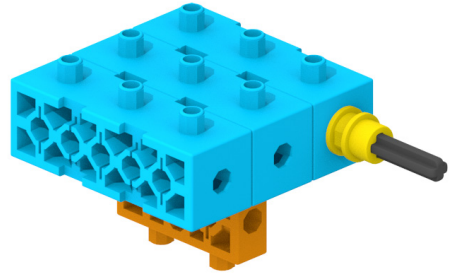

8

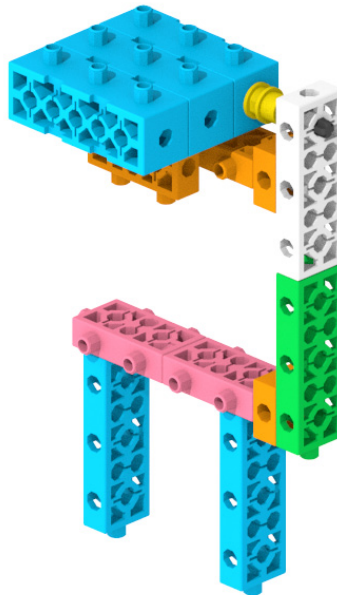

9

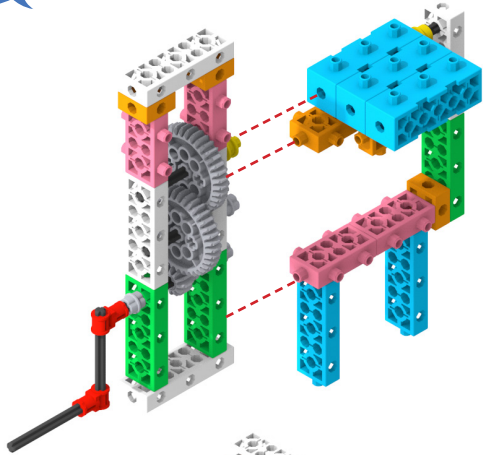

10

 x2  x2

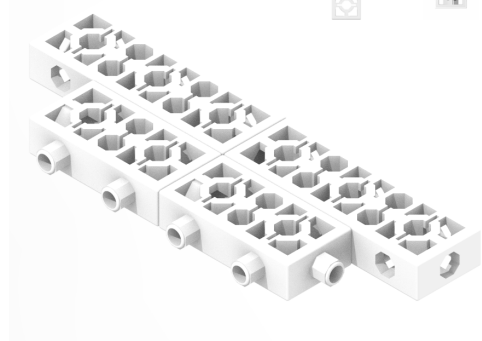

11

 x2  x2  x2

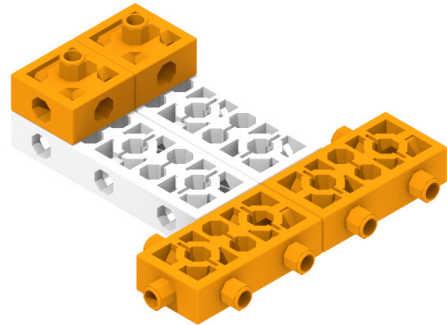

12

 x2  x1  x1  x2

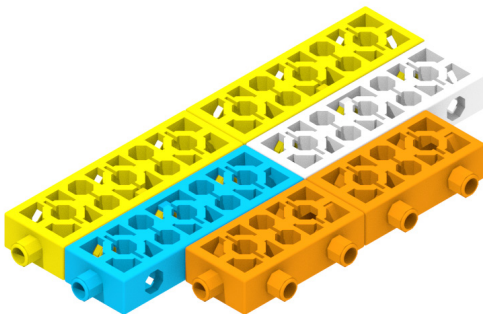

13

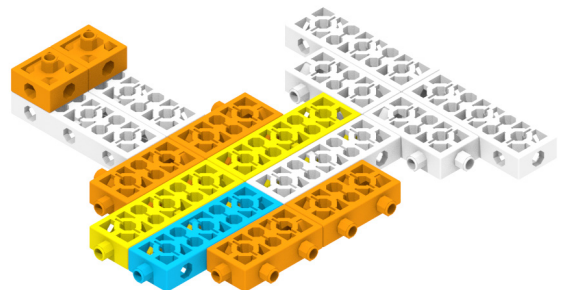

14

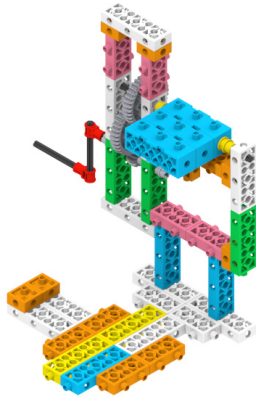

15

X4
A14



X1
A45

X4

X1

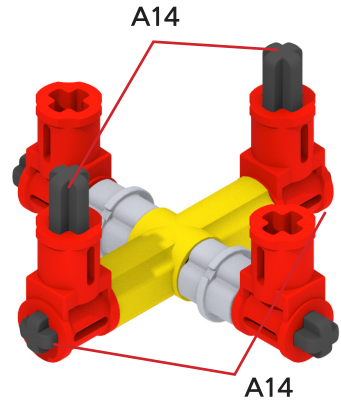

16

X2
A14

X3
A23

X2

X3

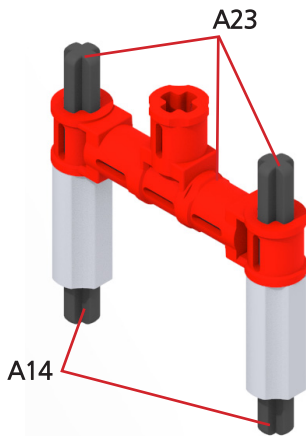

17

X4
A23



X1
A45

X2

X1

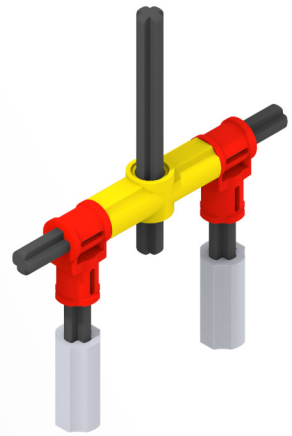

18

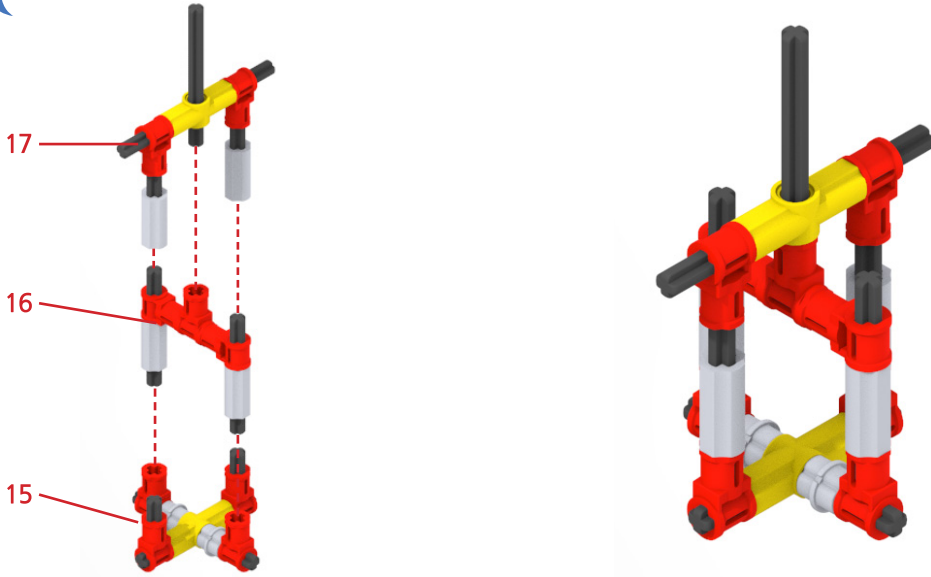

19

x1 x2

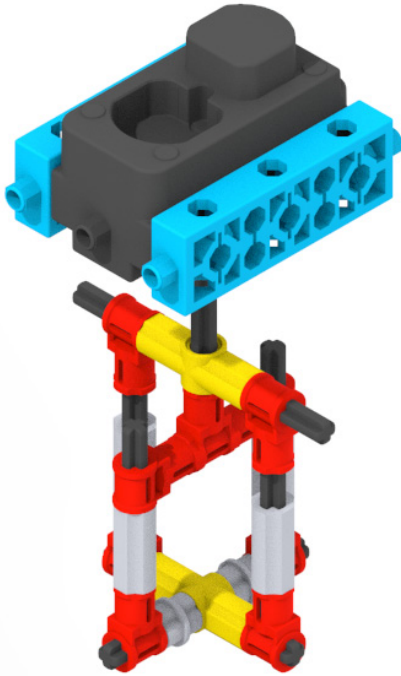

20

x6

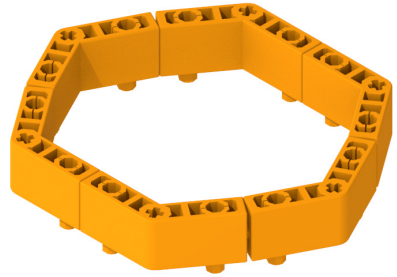

21

x4 x4 x4

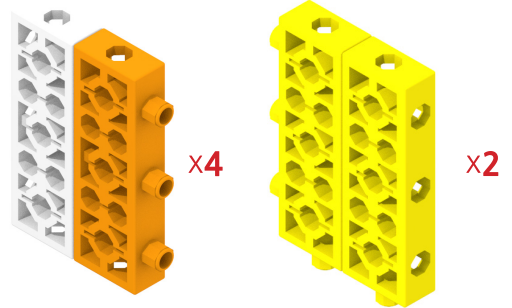

22

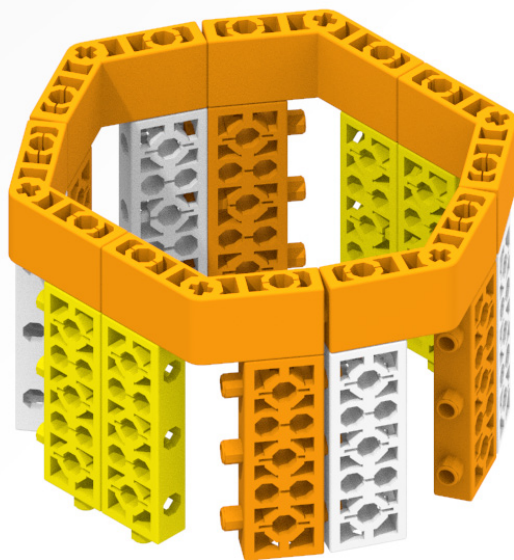



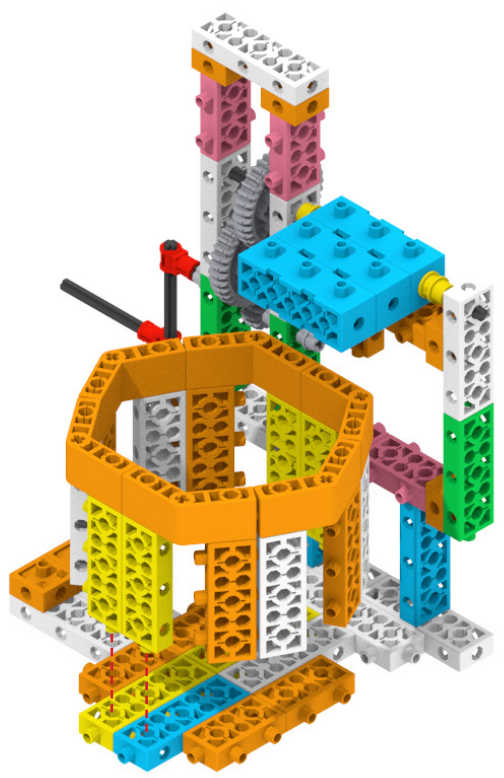

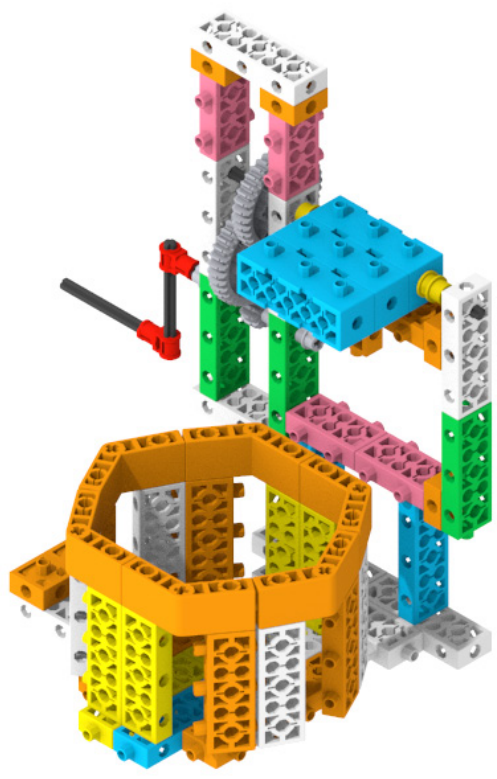

23



24



25

-  x1
-  x1
-  x1
-  x1
-  x3
-  x1

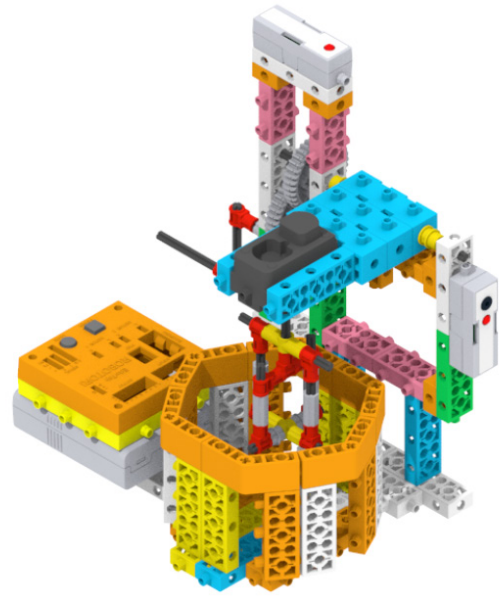

First, construct the mixer. Then, attach the electronics in the following order:

Step 1. Connect mainboard, battery case and Bluetooth together.

Step 2. Plug in the DC motor so that its red wire is facing the top of the mainboard and the black wire is facing the bottom.

Step 3. Plug the Button Sensor into the third section of the INPUT using a connection jack

Step 4. Plug the LED Sensor into the first section of the OUTPUT using a connection jack.

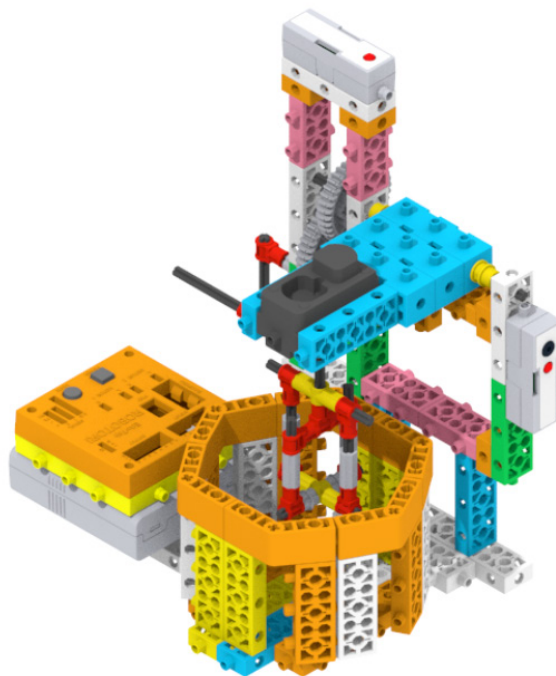
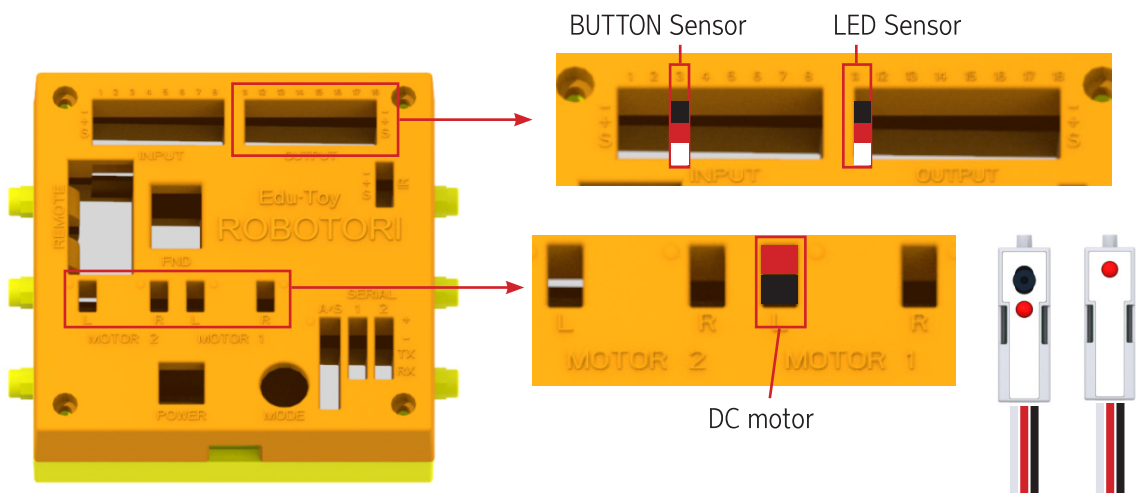

The Button Sensor & Menu



Simply put, the button sensor is the ability to have your robot function at the literal press of a button.



Here's how to set it up in the ROKIDS Plus app:

- In the top right corner of the app, you'll see an icon with the word "BUTTON" below it.
- Tap that to open the button menu
- Change the "BUTTON" setting from OFF to ON

Mastering the Button Sensor

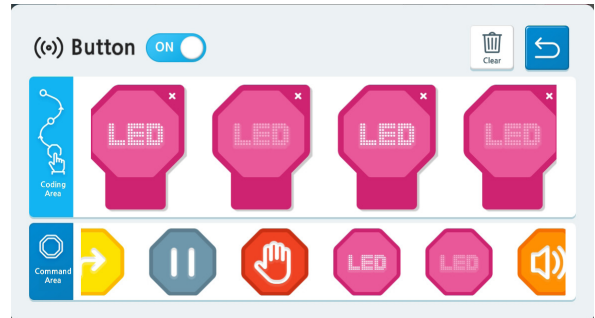

Code at main coding area commands 'Rotate motor clockwise and counter-clockwise alternatively continuously' while code at button coding area commands 'Repeat turning on / off LED twice' Regarding following picture, when you click button sensor while 'Code 1' that is main coding is under processing, then button coding, all of 'Code 2' is first proceeding and then returns to main coding then 'Code 3' is proceeding.

Click the
BUTTON
SENSOR
↓

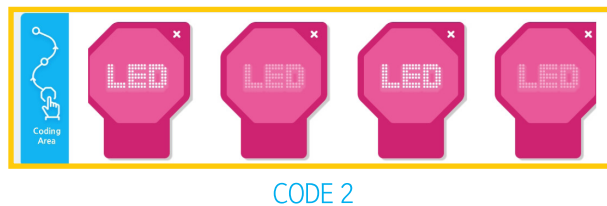

Shall we press play for Mixer?

When motor rotates clockwise / counter-clockwise, you can see motor pause for a while and LED displays red color blinking whenever you push button sensor and then motor rotates again

Shall we use BUTTON sensor more?

After you make a code as below, let's observe movement of mixer

Click the BUTTON SENSOR



After mixer's motor rotates counter-clockwise three times and you push button sensor, then you can see that motor rotates clockwise twice and LED blinks once and motor rotates counter-clockwise three times.

Shall we practice another example?

After you make a code as below, let's look into movement of mixer



Main code

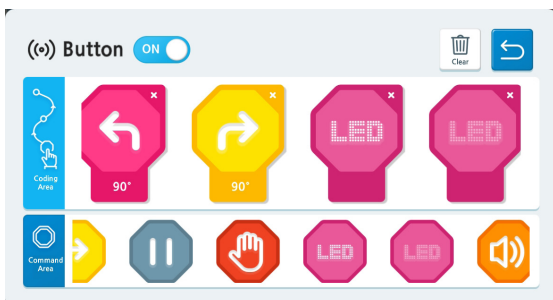

Button sensor code

Let's make a code as below using Mixer

Make codes so that when coding that DC motor for mixer rotates clockwise once and pauses a second is repeated unlimitedly, if you push button sensor, motor rotates counter-clockwise twice and turns on LED once and then turns it off.

Make codes so that when turning on / off mixer's LED is repeated 4 times, if you press sensor then DC motor rotates clockwise once and then counter-clockwise once.

Answer 1)

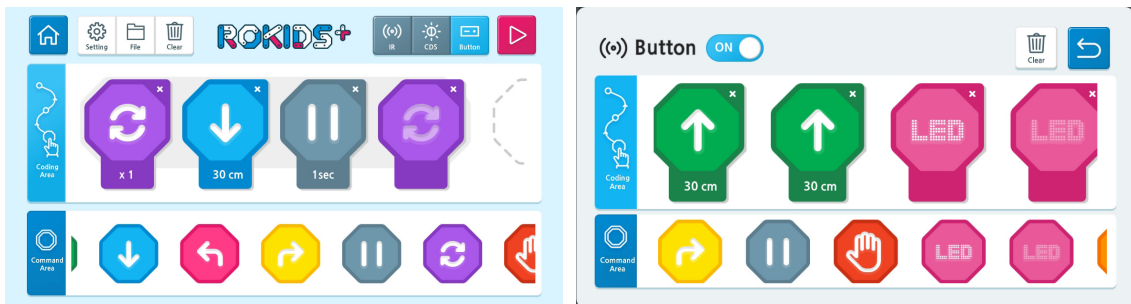

Answer 2)

