

Introduction to ROKIDS Plus and the Electronics Chapter 1

What is ROKIDS Plus?

ROKIDS Plus is a mobile app that lets you study coding in-depth by using a variety of buttons and sensors. Using basic coding, you'll be able to send commands to your robot to make it move forward, backward, left or right using DC motors.

In addition to this, you'll also be able to program your creations to various other things, like blink a light, react to light and darkness, and even both of those at the same time! You'll even be able to program your creations to play music.

The ROKIDS app is available for free download in that Apple App Store. Simply search for ROKIDS Plus! Note: Make sure to download ROKIDS Plus, not ROKIDS.

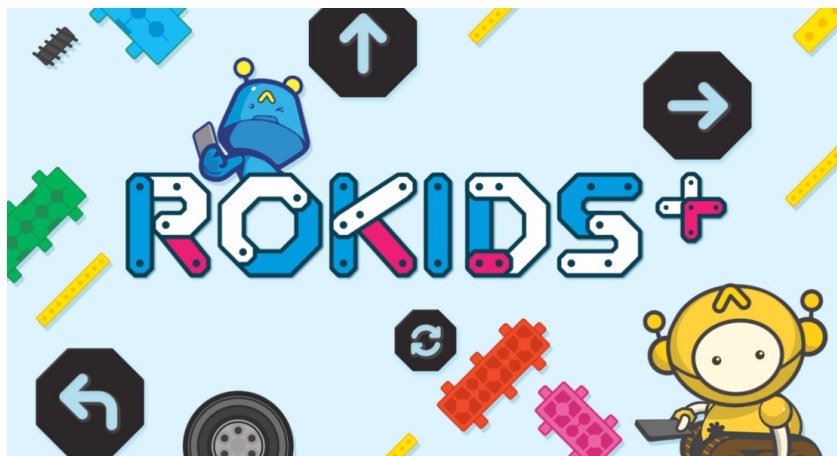

Introduction to the Mainboard

The mainboard is essentially the brain that controls the robot. Without the mainboard, your robot will be unable to function. This board enables the robot to move when it receives commands via the mobile app or Bluetooth.

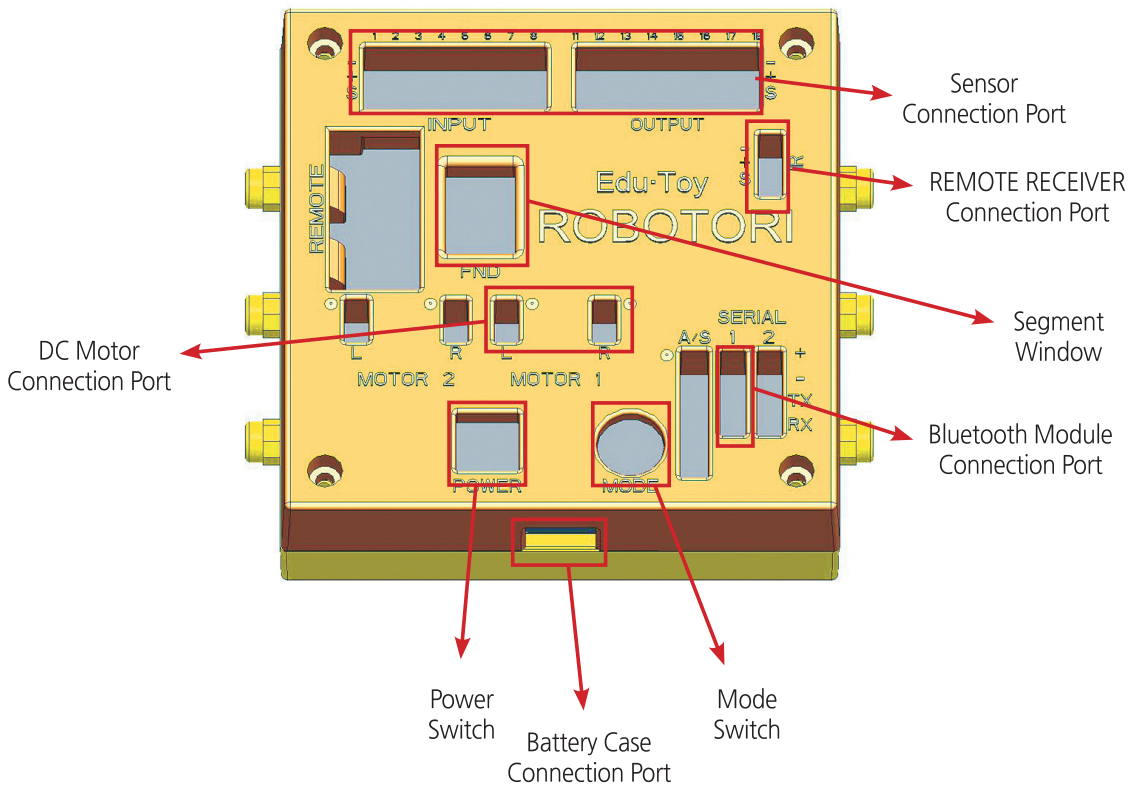

- Power Switch: Turns on or off the power
- Mode Switch: Changes the mode
- Segment Window: Displays operation mode for mainboard
- Battery Case Connection Port: Connects to the battery case
- Bluetooth Module Connection Port:: Connects to Bluetooth module
- Sensor Connection Port: Connects to Sensors
- DC Motor Connection Port: Connects to DC Motor

Introduction to the Battery Case

The battery case supplies the mainboard with power using the connection jack. You can turn on the power by pressing the power switch after connecting the battery case.

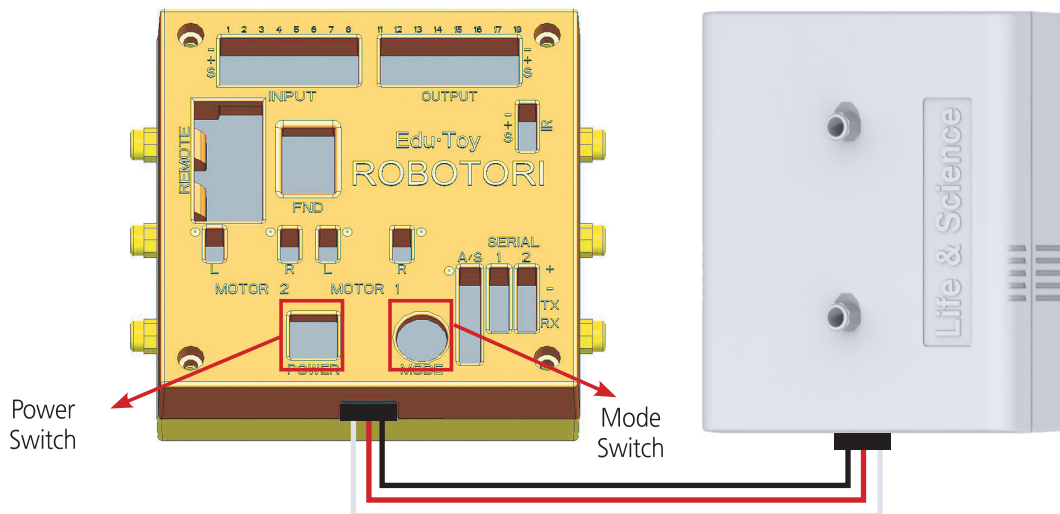

※ How to Set the Mode on the Mainboard

Setting the mode on the mainboard is simple. Each of the mainboard modes has its own special function, but only one will be important when using ROKIDS Plus.

1. Power on the mainboard and press “Mode” switch multiple times.
2. If “J” is displayed on the segments window, pause and wait for the LED to stop blinking.
3. After the screen blinks three times, the mainboard will be set to whichever setting is displayed.

※Caution : When using the ROKIDS Plus app, make sure that your mainboard is set to “J”!

Introduction to the Bluetooth Module

This module connects the mobile app to the robot. This is how you control the robot from the app, don't forget to include it in your build!

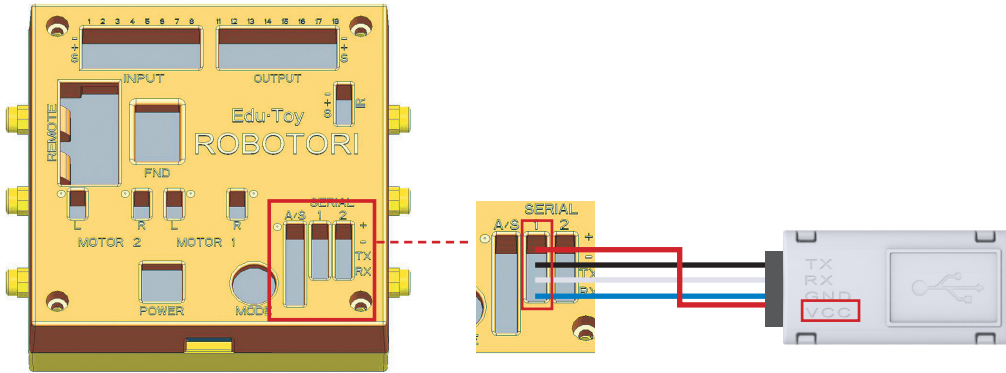

Introduction to Sensors

A sensor will input or output signal to or from the mainboard. For example, there is a sensor that detects light, but there's also a sensor that outputs an LED light.

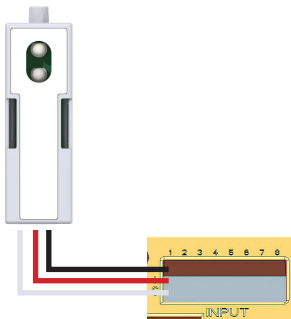
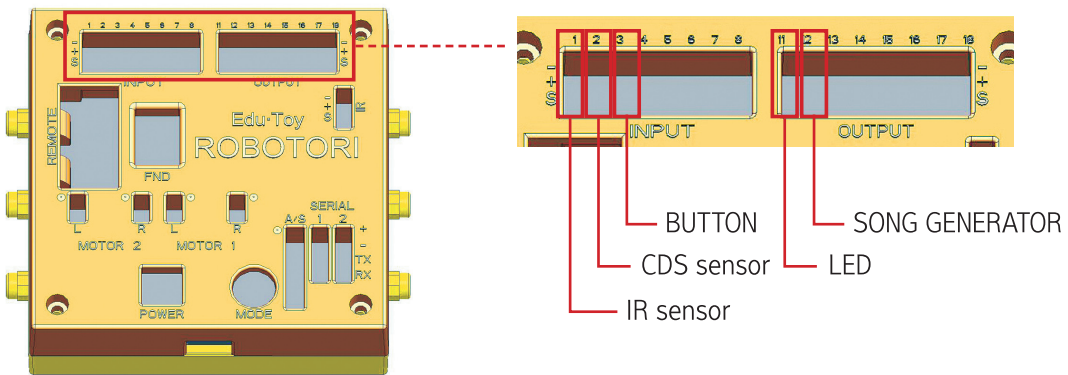

When connected into the sensor, the wires should be arranged:
White - Red - Black
When connected into the mainboard, the wires should be arranged:
Black - Red - White

Remember: Always connect sensors and the mainboard so that the white cable is always in the S-slot.

Installing the ROKIDS Plus App

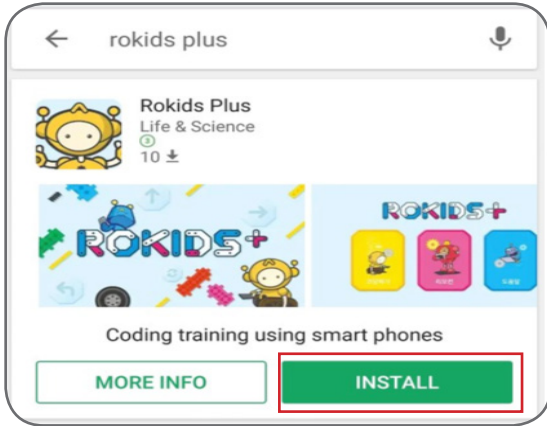

1. Search 'ROKIDS Plus' from the Apple App Store

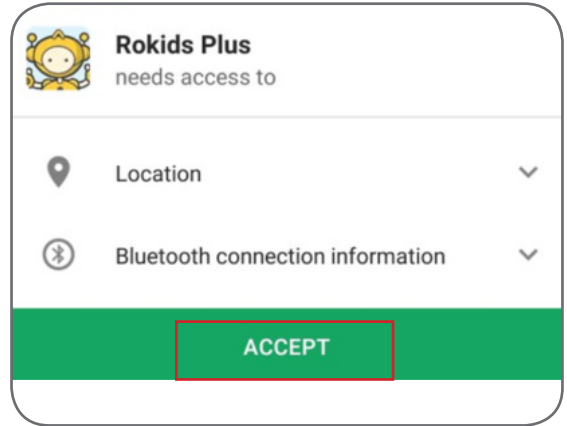

2. Confirm and install the app

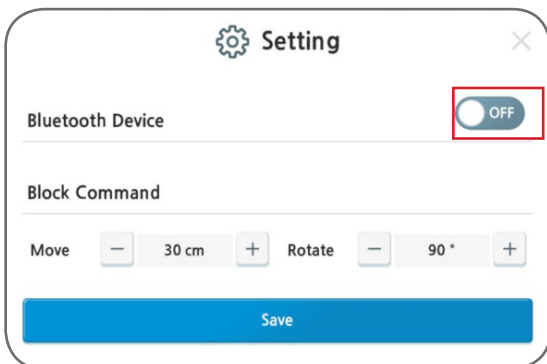

3. Turn on the Bluetooth in the settings menu by pressing the button in the top corner of the app

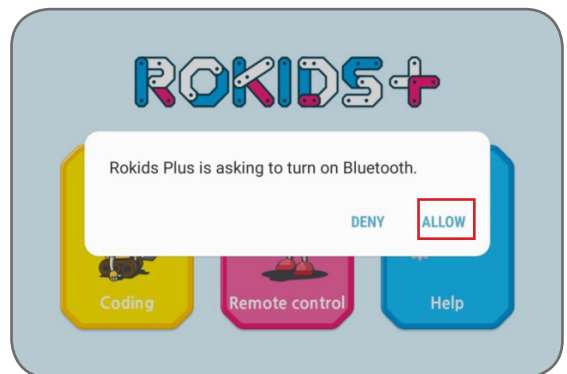

4. Activate the Bluetooth function

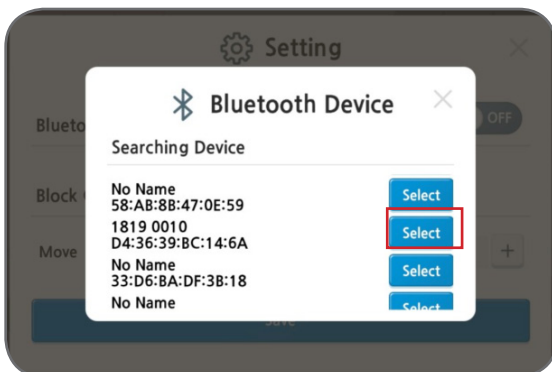

5. Make sure that the correct Bluetooth module is synced up to the ROKIDS Plus app

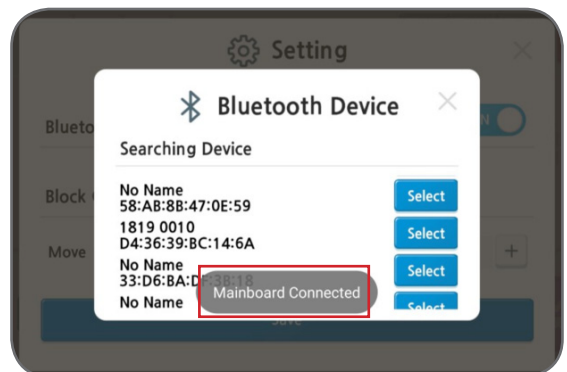
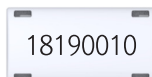

6. The Bluetooth connection should be complete

HOME MENU OPTIONS



Coding: This is the menu you use for “free” coding

Remote Con: This menu allows you to adjust the robot’s position, forward backward, left or right using a remote control

Help: This menu will help explain how to use the ROKIDS Plus app

Learning the ROKIDS Plus Menu

The screenshot shows the ROKIDS Plus app interface. At the top is a navigation bar with icons for Home, Setting, File, Clear, ROKIDS+ logo, IR, CDS, Button, and a play button. Below this is the Coding Area, which contains four dashed octagonal slots. At the bottom is the Command Area, which contains seven octagonal buttons: a green up arrow, a blue down arrow, a pink left arrow, a yellow right arrow, a grey pause button, and a purple refresh button.

Home Icon: This will take you back to the home screen of the app

Setting Icon: This is where you make sure your robot is connected to the Bluetooth. In addition, this is where you adjust the values for the Move and Rotate commands

File: This is where you’ll save and retrieve coding data you’ve made

Clear: This will delete your commands

IR Sensor Icon: This will take you to the IR menu

CDS Sensor Icon: This button will take you to the CDS menu

Button Icon: This will open the button menu

Coding Area : This is where you will drag and drop the icons from the Command Area. One code fits in each slot, and the codes will always be executed from left to right

Command Area : This is where you can find all the commands that you can make your creation perform

Learning the ROKIDS Plus Menu



Forward Button:
Commands your robot to move forward



Backward Button:
Commands your robot to move backward



Left Rotation Button:
Commands your robot to turn left, counter-clockwise



Right Rotation Button:
Commands your robot to turn right, clock-wise



Repeat Button: Commands your robot to repeat a specified set of commands



Pause Icon: Commands your robot to halt for a set period of time.



Turn On LED Button: When the LED Sensor is installed, this will turn the LED on



Turn Off LED Button: When the LED Sensor is installed, this will turn the LED off



Turn On Song Generator:
When the Song Generator is installed, this will turn the Song Generator on



Turn Off Song Generator:
When the Song Generator is installed, this will turn the Song Generator off



Finish Button: Commands your robot to stop performing whatever actions are programmed.

The Scissor Lifter

Chapter 5

04

Scissor Lift

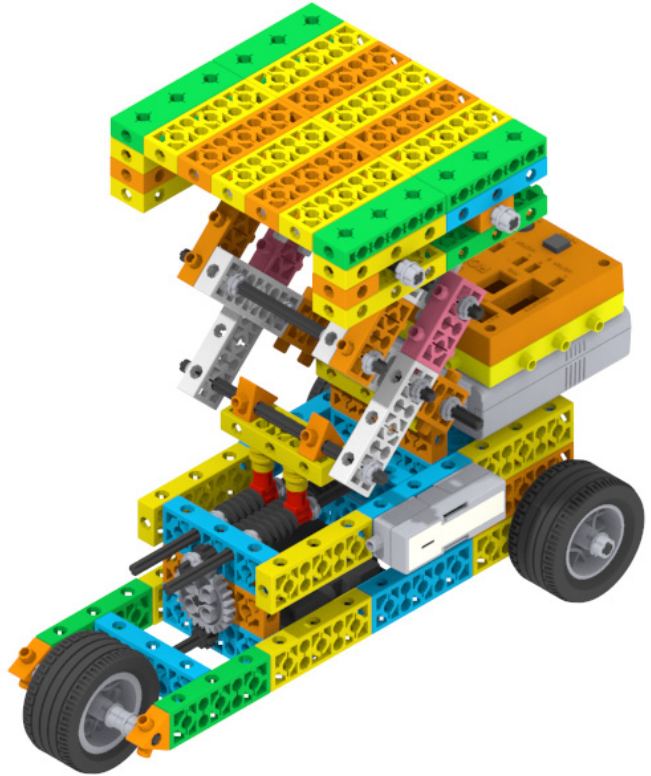

Assembling the Scissor Lifter

Rubi 8 (1)	Rubi 6 (9)	Rubi 2 (14)	Rubi 2 (4)	Rubi 0 (8)	Rubi 0 (20)	Mini 2 (4)	Mini 2 (2)	Mini 2 (2)	Mini 1 (6)	Dia mini 6 (4)	Triangle (6)	Sawtooth 8 (2)
Sawtooth 24 (1)	Crown (2)	Worm (5)	Short connector(26)	Middle Connector(20)	Long connector(3)	Vertical Connector(2)	Motor connector(2)	A23 (1)	A45 (1)	A64 (8)	A96 (9)	Formula wheel (3)
DC motor (2)	SONG GENERATOR(1)	Battery case (1)	Bluetooth module (1)	Main board (1)	Connector (2)							

1

	x2		x1		x2		x2		x6		x3	A96
---	----	---	----	---	----	---	----	---	----	--	----	-----

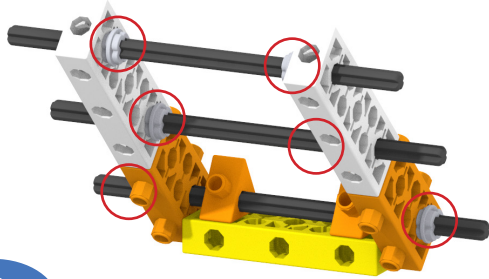

2

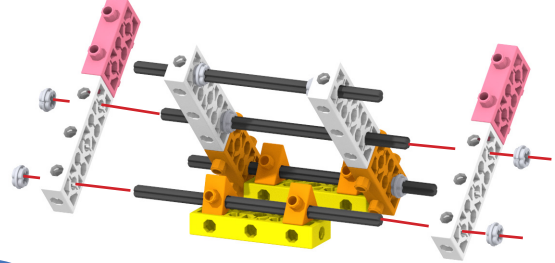

	x2		x2		x1		x2		x4		x1	A96
---	----	---	----	---	----	---	----	---	----	--	----	-----

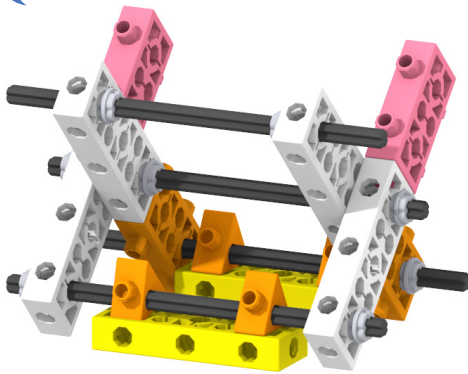

3





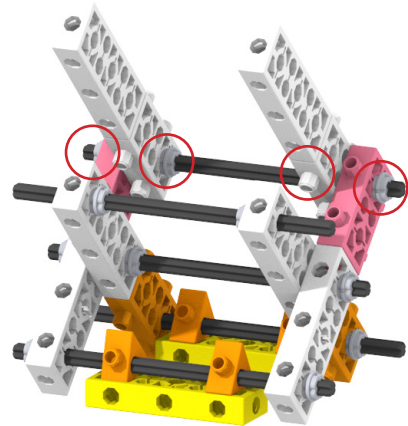

4

	x2	
	x2	
	x1	A96
	x4	



5

	x2	
	x2	
	x1	A96
	x6	

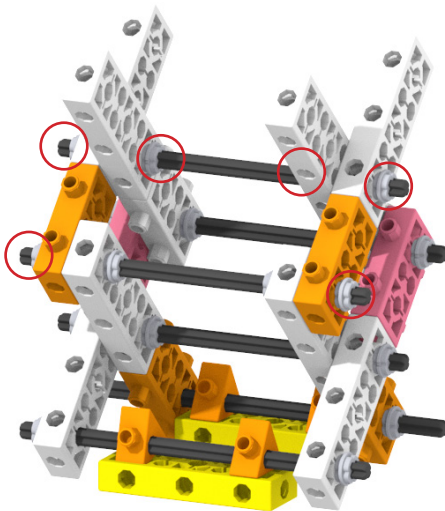

6

	x2		x4	A64
---	----	--	----	-----

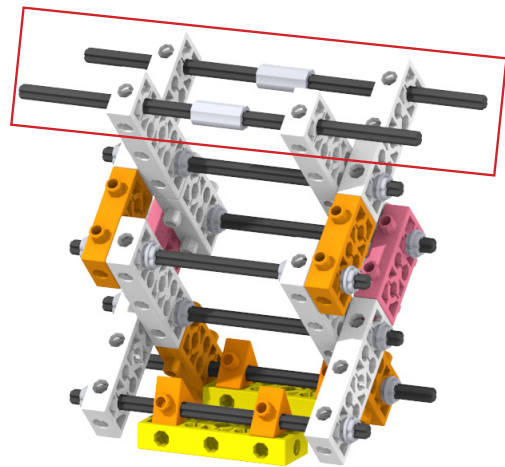

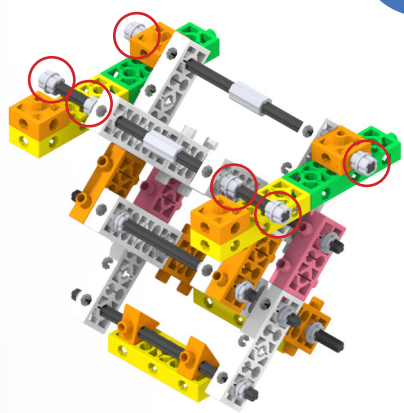

7

-  x2
-  x2
-  x4
-  x6



8

-  x2
-  x2
-  x5

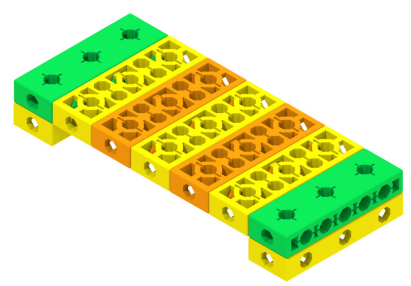

9

-  x2
-  x2
-  x3
-  x2

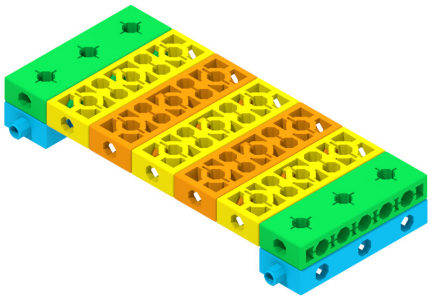

10

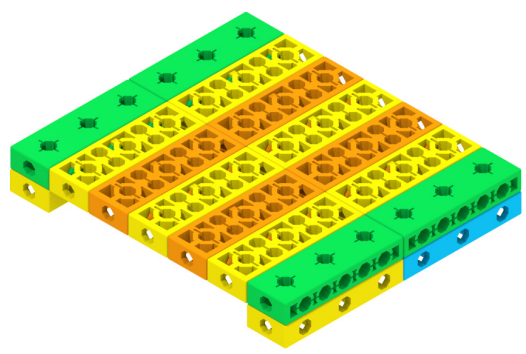

11

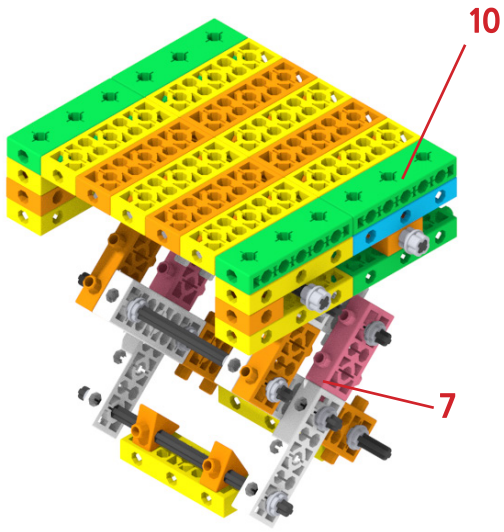

12

-  x2
-  x1
-  x1
-  x4
-  x1
-  x2

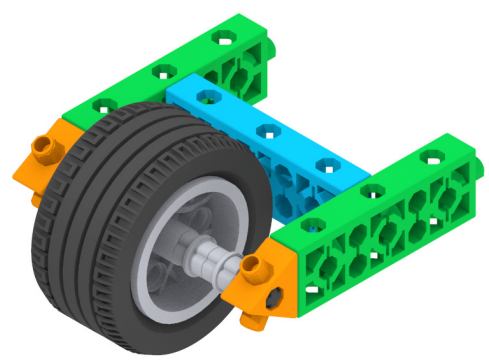

13

1x1 Blue Technic Beam
x2x2 Yellow Technic Beam
x1x2 Yellow Technic Beam
x1 A23
x1 A45
x1 Black Technic Pin

x1 Black Technic Pin
x1 Grey Gear
x1 Grey Technic Pin

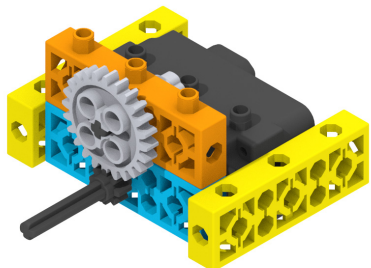

14

1x1 Blue Technic Beam
x2x2 Yellow Technic Beam
x2 A14
x3 A96
x1 Black Technic Pin
x5 Grey Technic Pin

x1 Grey Technic Pin
x5 Black Technic Pin
x2 Yellow Technic Pin
x2 Red Technic Pin

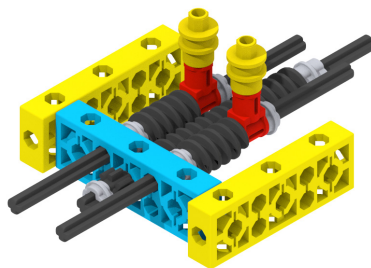

15

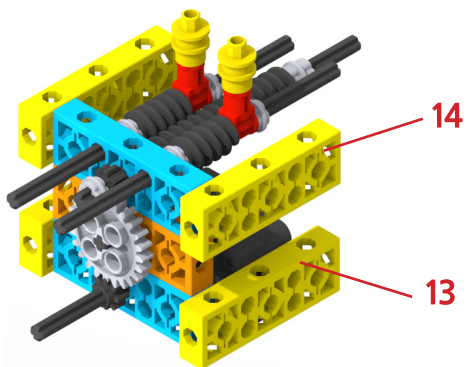

16

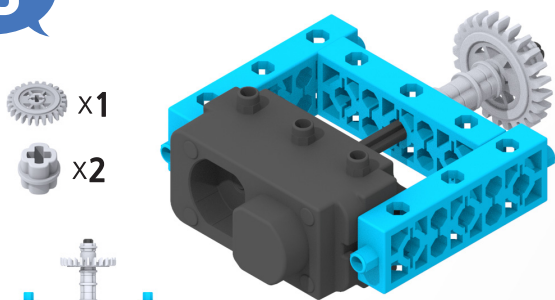

x1 Grey Gear
x2 Grey Technic Pin

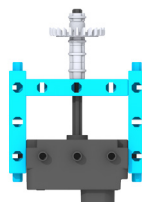

x3 Blue Technic Beam
x2 Grey Technic Pin
x1 Black Technic Pin
x1 A64

17

x4 Blue Technic Beam
x2 Yellow Technic Beam

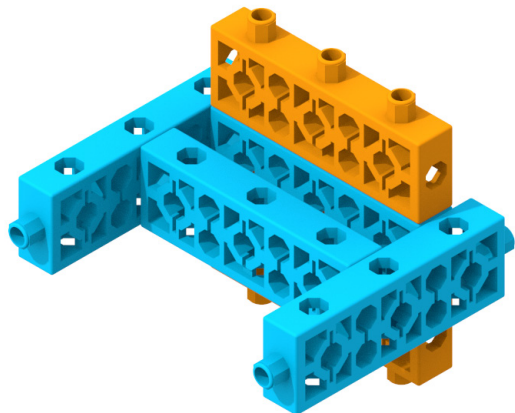

18

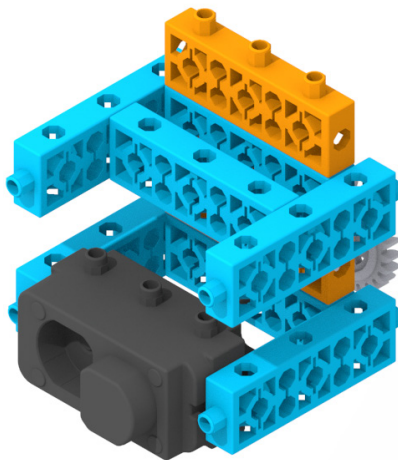



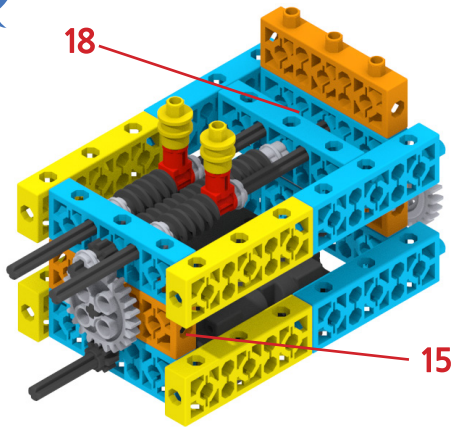

19

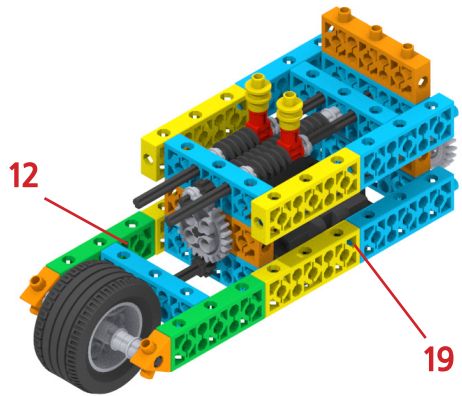

20





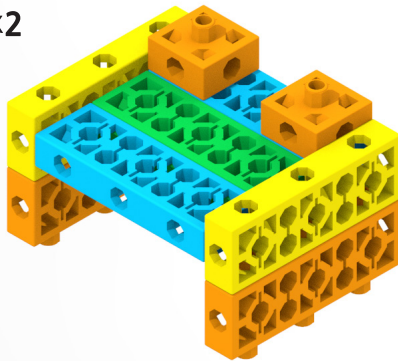

21

-  x1
-  x2
-  x2
-  x2
-  x2



22

-  x2
-  x2
-  x2
-  x1
-  x1

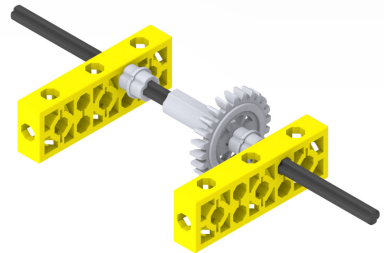

23

-  x4
-  x2

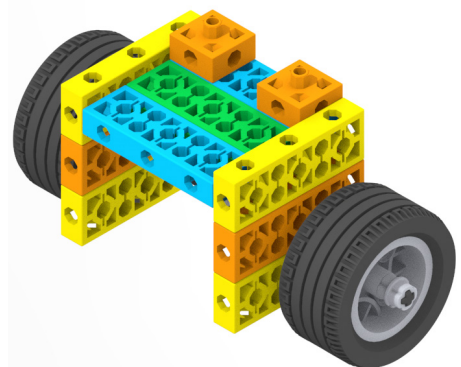
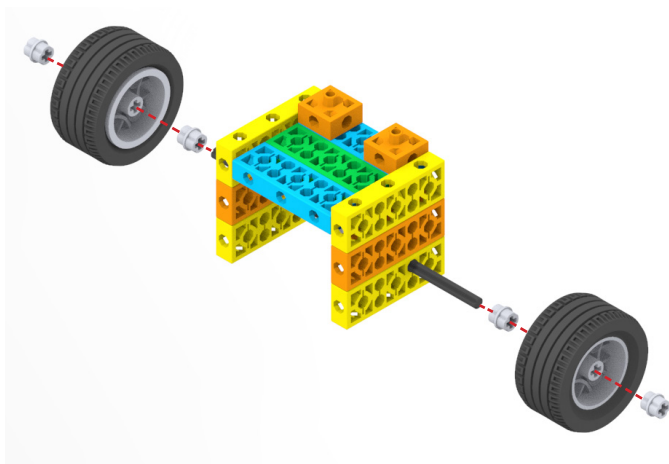

24

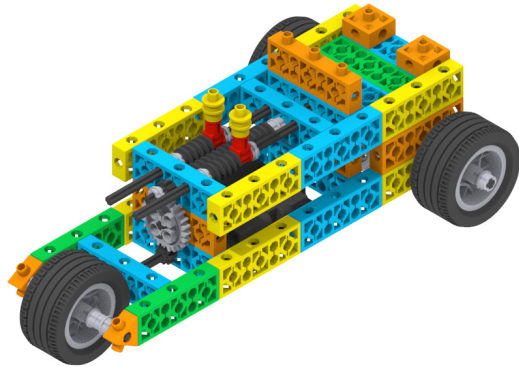

25

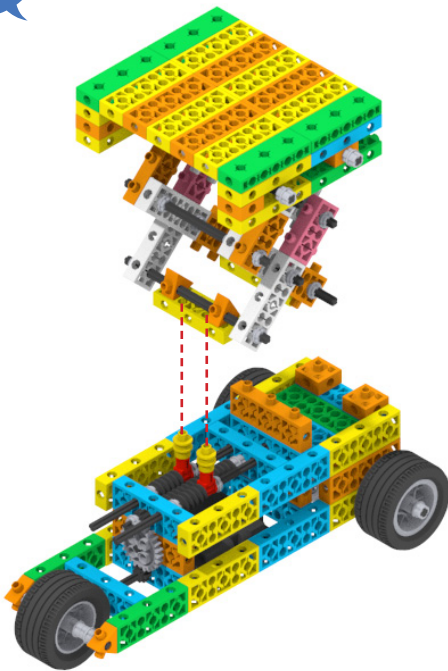

26

-  x1
-  x1
-  x2
-  x1
-  x1

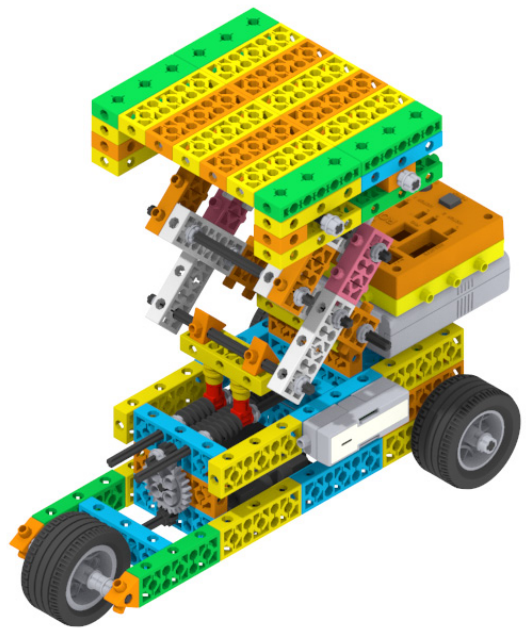

Assembling the Scissor Lifter

First, construct the scissor lifter. Then, attach the electronics in the following order:

Step 1. Connect mainboard, battery case and Bluetooth together.

Step 2. Plug in the DC motor so that its red wire is facing the top of the mainboard and the black wire is facing the bottom.

Step 3. Plug the “Song Generator” sensor into the second section of the OUTPUT using a connection jack.

Note: Make sure both the front and rear motors are properly situated for the scissor lifter to work!

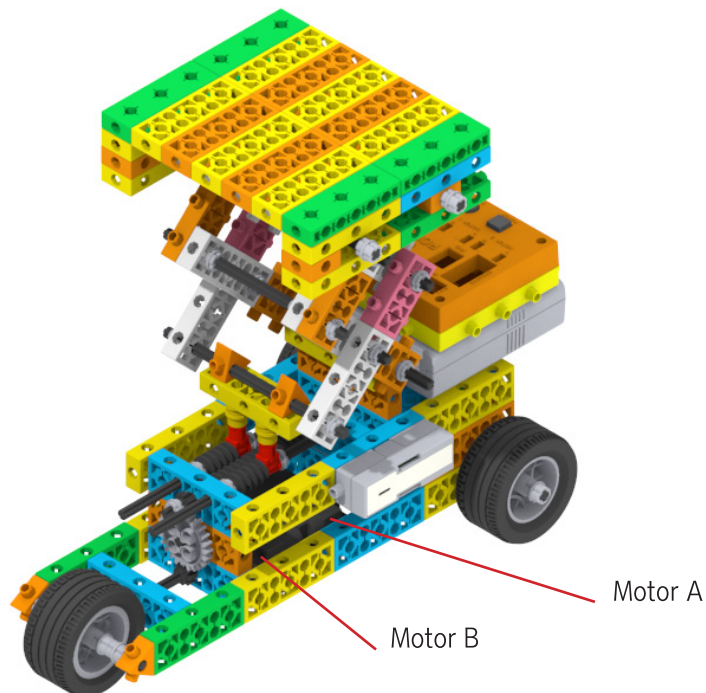
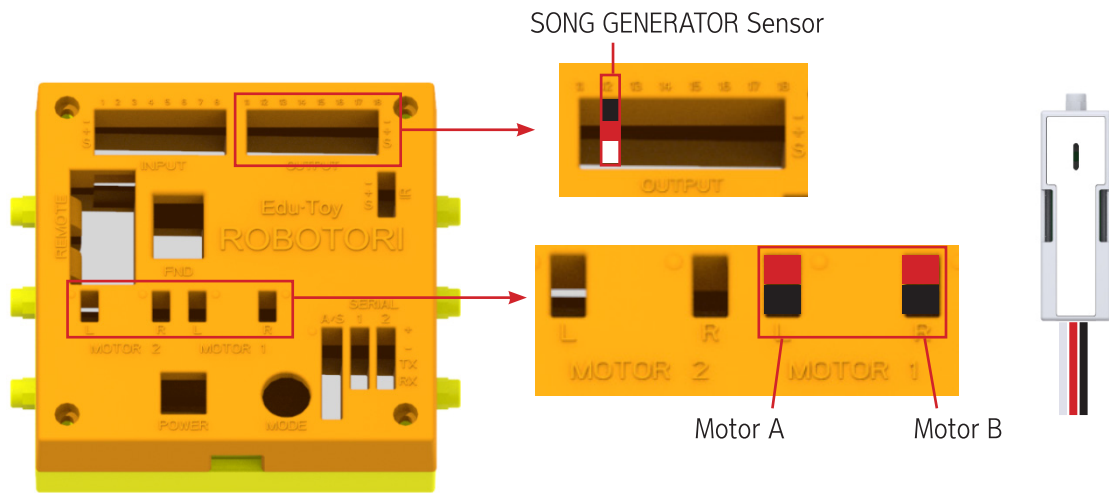

The Song Generator Sensor & Block



The “Song Generator” sensor is exactly what it sounds like; when the sensor is inserted and turned on, your creation will play music! Like the other sensors, this has its own unique block that you’ll use when inputting any song generator commands into your robot. Because this robot makes noise, it is going to always be plugged into the second section of the OUTPUT on the motherboard. Notice how there are individual commands for turning the song generator on and off.

Shall we use block for turning on / off SONG GENERATOR more?

Let's look into SONG GENERATOR for Scissor lifter after you performed coding as below

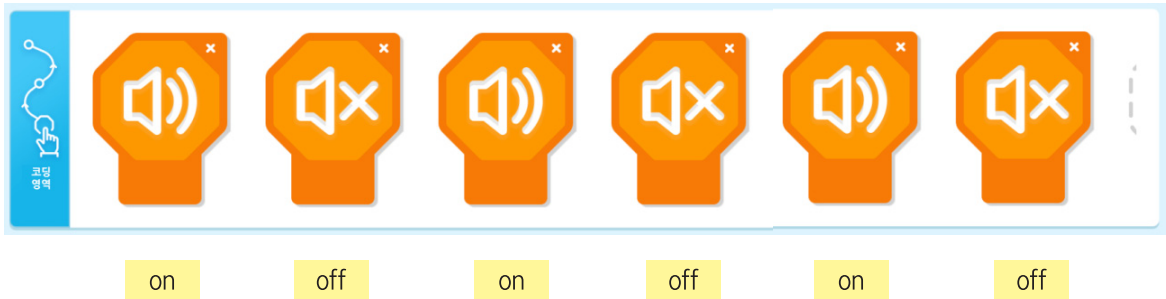

The above code enables turning on / off SONG GENERATOR's sensor to be repeated three times. You can see that only front part is shortly played buzzing "Ddi Ddi Ddi" and finish code.

Shall we make a code which enables to hear melody more?

After you make a code as below, let's hear how SONG GENERATOR for Scissor lifter plays song.



If you push play button only by block for turning on/off SONG GENERATOR and melody is played unlimitedly.

Shall we use block for turning on/off SONG GENERATOR more?
Let's look into movement of scissor lifter after you make codes as below



When you press play button, you can see melody play and scissor lifter move forward and ladder be folded and then unfolded then melody stops.

Let's do coding as below and look into how scissor lifter moves

