

# 부품리스트

## 헤비셀

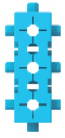

Diamond H8  
x 2



Diamond H6  
x 2



Diamond d V8  
x 6



Diamond V8  
x 2



Diamond V6  
x 4



Diamond V6  
x 4



Diamond V6  
x 6

## 라이트셀



Dia Mini 8  
x 1



Rubi 8  
x 1



Rubi 7  
x 7



Rubi 4  
x 8



Rubi 2  
x 4



Rubi 2  
x 3



Rubi 2  
x 6



Rubi 0  
x 8



Mini 2  
x 8



Mini 2  
x 2



Mini 2  
x 1

# 분리도구 사용법

## Example 1

셀의 돌기와 돌기를 분리할 때

## Example 2

셀의 홈과 홈을 분리할 때

## Example 3

셀의 홈과 돌기를 분리할 때

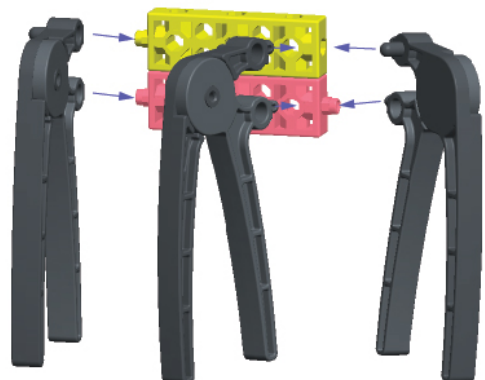

Example 1

Example 2

Example 3

특수셀



Curve  
x4



Curve  
x2



Link  
x8



Octacell  
x2



Octacell Mini  
x1

축



A23  
x4



A45  
x2



A64  
x5



A96  
x2

기어& 연결책



12 톱니바퀴  
x2



36 톱니바퀴  
x2



짧은연결책  
x2



중간연결책  
x2



긴연결책  
x1



직각연결책  
x4



모터연결책  
x8

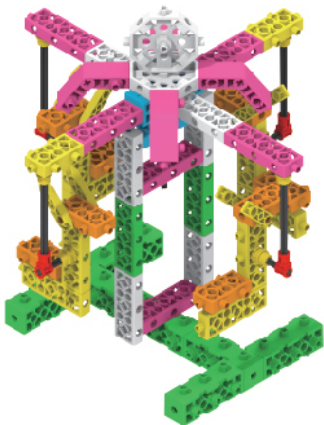

회전목마

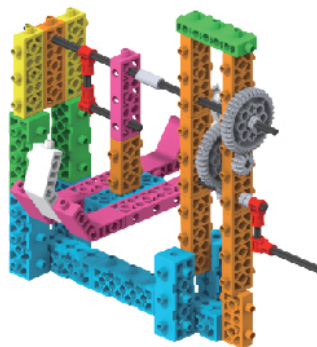

바이킹

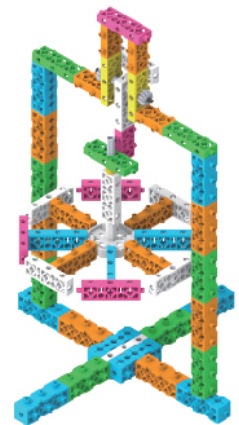

허리케인



# 01

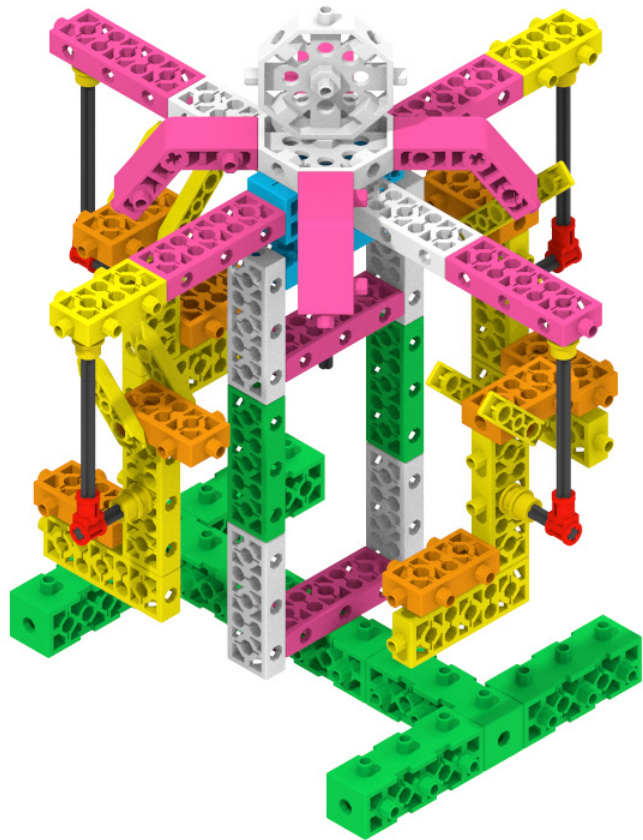

## 회전목마



회전목마 부품리스트 | 구조물을 만들어 봅시다.

Diamond H6 (1)	Diamond V8 (3)	Diamond V6 (4)	Rubi 4 (8)	Rubi 2 (1)	Rubi 2 (2)	Rubi 2 (6)	Rubi 0 (6)	Mini 2 (8)	Mini 2 (2)	Curve (4)	Octacell (2)	Link (8)
짧은연결축 (1)	중간연결축 (1)	모터연결축 (8)	직각연결축 (4)	A23 (4)	A64 (5)							

1

-  x3
-  x4

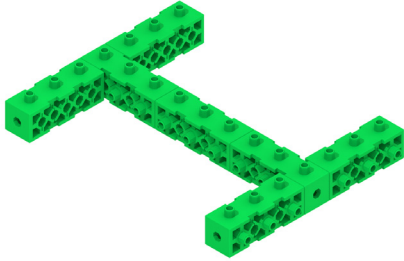





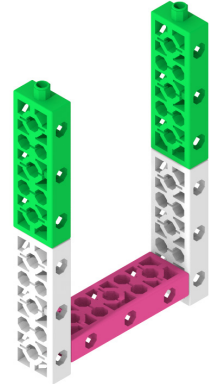

2

-  x2
-  x1
-  x2



3

-  x1
-  x1
-  x2
-  x1
-  x1
-  x1
-  x1

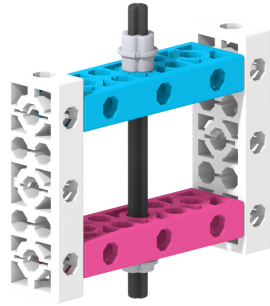

4

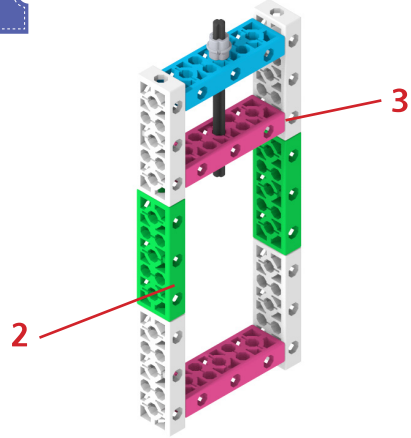

5

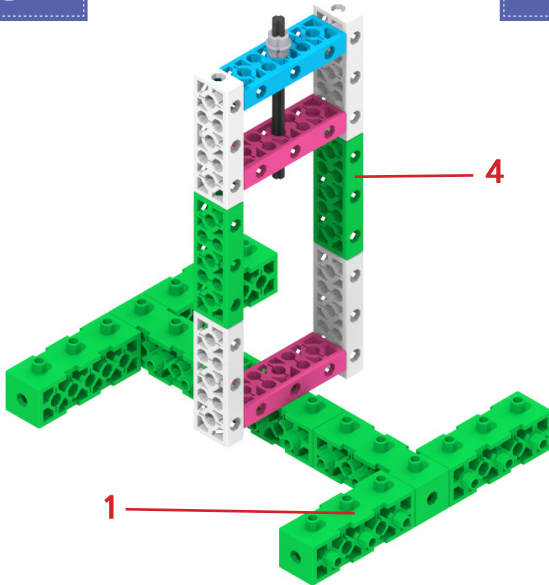



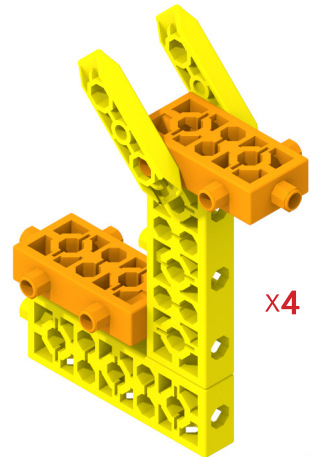

6

-  x8
-  x8
-  x8



7

-  x2
-  x2
-  x2
-  x2
-  x4



8

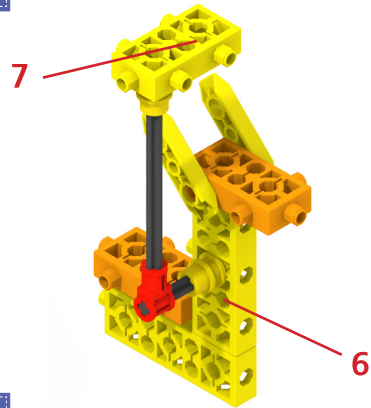

9

-  x2
-  x2
-  x2
-  x2
-  x4

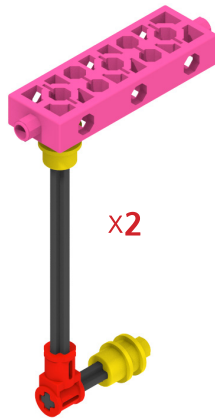

10

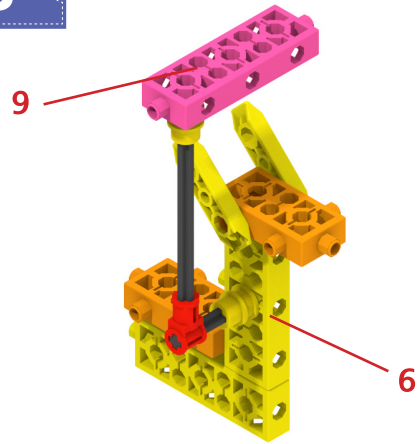

11

-  x1
-  x2
-  x2

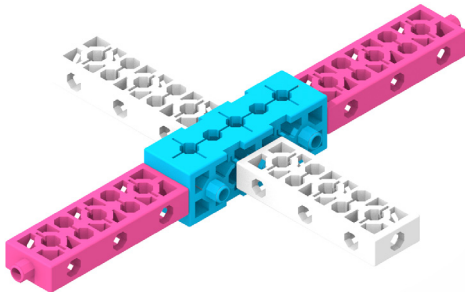

12

-  x4
-  x2

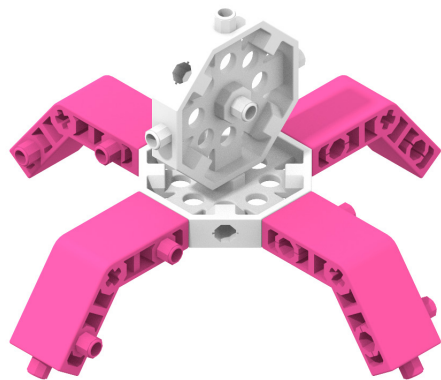

13

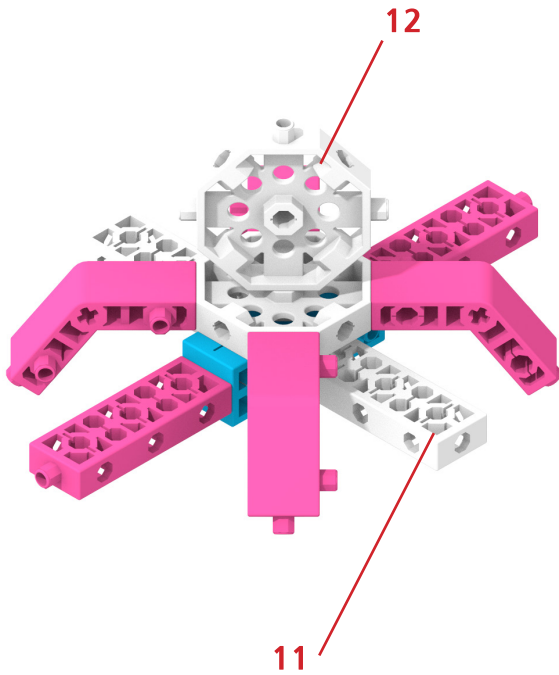

14

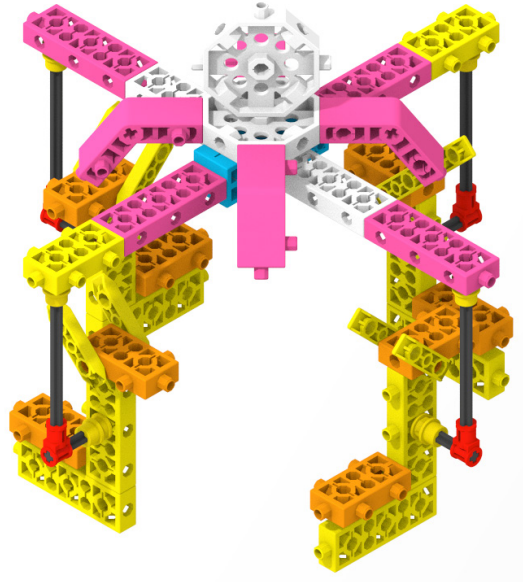

15

